

The logo for FIBRAIN, featuring the word "FIBRAIN" in a bold, white, sans-serif font, followed by a stylized red and white graphic element resembling a square with a horizontal bar through it, and a registered trademark symbol (®) to the right.

**FIBRAIN** ®

The main title of the document, "FibraIn DATA Structured Cabling", is displayed in a large, white, sans-serif font. The text is centered and overlaid on a background of a perspective view of a grid of metal mesh, with a red and cyan color scheme applied to the grid lines.

**FibraIn DATA**  
Structured Cabling

|  |                |                  |
|--|----------------|------------------|
| <b>FIBRAINDATA</b>                           |                |                  |
| <b>COPPER INSTALLATION CABLES</b>            | <i>Page 10</i> | <b>CU</b>        |
| <b>COPPER CONNECTORS</b>                     | <i>Page 28</i> | <b>CU</b>        |
| <b>COPPER PATCH PANELS</b>                   | <i>Page 36</i> | <b>CU</b>        |
| <b>COPPER PATCH CORDS</b>                    | <i>Page 49</i> | <b>CU</b>        |
| <b>COPPER TERMINATION OUTLET ACCESSORIES</b> | <i>Page 56</i> | <b>CU</b>        |
| <b>CABINETS</b>                              | <i>Page 64</i> | <b>CU<br/>FO</b> |
| <b>CABINETS ACCESSORIES</b>                  | <i>Page 71</i> | <b>CU<br/>FO</b> |
| <b>FIBRAIN LOGIWIRE</b>                      | <i>Page 76</i> | <b>CU<br/>FO</b> |

|  |                 |           |
|--|-----------------|-----------|
| <b>FIBER OPTIC INSTALLATION CABLES</b>     | <i>Page 87</i>  | <b>FO</b> |
| <b>FIBER OPTIC CONNECTION HARDWARE</b>     | <i>Page 96</i>  | <b>FO</b> |
| <b>FIBER OPTIC PRECONNECTORIZED CABLES</b> | <i>Page 106</i> | <b>FO</b> |
| <b>FIBER OPTIC PATCH PANELS</b>            | <i>Page 120</i> | <b>FO</b> |
| <b>PATCH PANELS ACCESSORIES</b>            | <i>Page 137</i> | <b>FO</b> |
| <b>FIBER OPTIC TERMINATION OUTLETS</b>     | <i>Page 144</i> | <b>FO</b> |
| <b>FIBER OPTIC TEST ACCESSORIES</b>        | <i>Page 148</i> | <b>FO</b> |



# FIBRAINDATA

## FibrainDATA - striving High class components of structured



**RELIABILITY GUARANTEE**  
*Three-level warranty system:*  
product, system, application



**COMPLETE SOLUTIONS**  
Comprehensive portfolio  
of **FO & Copper structured  
cabling solutions**



**MANUFACTURING IN POLAND**  
Manufacturing centers are located  
in Rzeszów, Rogoźnica, Jasionka, Zaczerwie

# for perfection

cabling systems create complex solutions



## TRAINING SCHEME

Two-level training scheme  
to Certified Installers & Designers



## VERIFIED IN PROJECTS

More than **500 buildings** certified in Poland  
and **400 foreign installations**



## REQUIREMENTS FULFILLMENT

System verified in the independent 3P Third  
Part Test laboratory and in National Institute  
of Telecommunications

## ***FIBRAINDATA structured cabling***

Structured cabling solutions are well-known and fully certified solutions to meet specific requirements. Designed with assistance from network planners and installers, FIBRAINDATA guarantees ease of installation and the highest performance. Exceeding Standards, fulfilling highest requirements and ensuring warranty system for at least 25 years - these are the main goals, which we have in mind when designing FIBRAINDATA system. Undoubtedly, our dynamically developing R&D department and well-equipped laboratory are involved in a wide range of activities to achieve our aims and provide the best parameters.

### ■ Company

The principal aim of FIBRAIN company and a common target of all employees is a constant development of the company's profile and services, which meet ever-increasing market needs and customer's requirements. Therefore, one of the main priority is the ongoing expansion and advancement of the manufacturing capabilities. Thanks to highly experienced specialists from various departments, including H&R, company's development is smooth and consistent. Naturally, state-of-the-art technologies and equipment provide the possibilities to perform challenging tasks and customize company's products to meet or even exceed our customers' needs. Therefore, professional service and individual attitude to customers as well as constant upgrading the company's offer and products are one of the crucial priorities.

### ■ Knowledge

Experienced employees in R&D, Structured Cabling Department and other Department form a team of experts who are ready to take up any challenge. Having one of the best-equipped laboratories in Europe, we are able to test our systems operation in different conditions. The appropriate choice of materials used for production of individual components ensure the best system's transmission parameters and its operation during for at least 25 years. Our professional job attitude as well as commitment and highly qualified workers enable us to achieve the highest goals and ambitions, amongst others, being a world known leader in the telecommunications industry.

### System

The main aim of FIBRAINDATA is to create a solution, adjusted to the customer's needs in the best possible way. In order to improve products, FIBRAIN company organizes meetings with experienced technicians, which result in constant implementation of the new improvements in our components. As we have full control of the product, any modifications are implemented almost automatically. Therefore, as a consequence of being an independent company, we can design products and solutions which fulfill the requirements in our region. Therefore, we have managed to create a system corresponding to the needs of wide range of customers- the system of the XXI century. Wide and comprehensive portfolio of solutions allows us to adjust to individual configuration of IT network and gives us a competitive advantage in the market. Our own high requirements, resulted in not only fulfilling but exceeding the ISO/IEC 11801:2011, EIA/TIA-568-D.2.1, EN 50173:2013 Standards.

Our well-known and fully certified solutions are divided into specific systems which comply with the highest requirements and standards

### Copper Solutions

#### *Express 5e*

**Express** - Complete D-class system, includes all the components of 5e category which are required when structured cabling system is installed. The system is available in 2 options: UTP and FTP. In both solutions are based on cables with increased frequency up to 200 MHz. Additionally, system includes multi-pair cables of 5e category, which entirely comply with ISO/IEC 11801 norm.

#### *Quick 6*

**Quick** - Complete E-class system includes all components of 6 category which are required when structured cabling system is installed. Comprehensive portfolio of installation cables (U/UTP, F/UTP, U/FTP, S/FTP), as well as increased frequency up to 500 MHz, allow us to fulfill the requirements of even the most demanding customers.

#### *Rapid 6a*

**Rapid** - Complete EA-class system, contains complete range of 6A category components. Solutions fully provide 10Gbps transmission in complete 100m of transmission channel. A system is based on shielded version of transmission components.

#### ULTRA 77A

**Ultra** - Solutions are adjusted to future applications, ensuring assumptions of 7 and 7A categories. It is also based on high quality of telecommunication cables as F/FTP, S/FTP.

#### *Voice*

**Voice** - A system is prepared to be used in digital and analog telephone signal transmission. It perfectly complements telecommunication solution.

### Fiber Optic Solutions



**Fiber optic solutions** - Full comprehensive solution being a part of FIBRAINData cabling system. Offer of FIBRAIN consists of either MM and SM cabling which are segregated according to efficiency. Full scope categories OM1- OM4 for MM and OS1/OS2 for SM. Whole portfolio in full range is based on Bend Insensitive Multimode Fibers (BIMF) and Bend Insensitive Singlemode Fibers (BISF) what make the installation easier keeping the highest transmission parameters on adequate level. FIBRAINDATA offers complete scope of FO connectors, starting from legacy ST, FC ending on the most modern LC and MPO/MTP. FIBRAINData cabling system is ready for the most demanding applications including 40G and 100G in full range of length according to ISO11801 & IEEE

## ■ Compliance

All of our products have been examined by an external, independent laboratory as a component and also as a transmission channel and a permanent link. For an additional protection, all of them are measured on a daily basis in FIBRAIN internal laboratory and also reviewed by the installers after the implementation process. Moreover, each component is examined with the use of the re-embedded method.

## ■ FIBRAIN Academy

Responding to the market demand and to help our customers absorb new knowledge and technologies we offer a series of training courses under the common brand name FIBRAIN Academy. We welcome inquiries for customized training modules. As seasoned practitioners we can draw on years of experience and hundreds of projects completed so our courses of always practice-oriented. Therefore, meetings are always tailored to the partner's needs and preferences. Our trainers are open for a discussion and precious knowledge exchange.



## ■ Certified Installer

Authorized Program of the Certified Installers of FIBRAINDATA is aimed for companies which are focused on project, installation with implementation of structured cabling system. Training Program of Certified Installers conducted by our Product Managers provides essential knowledge, which is necessary to understand and install structured cabling system.

During the training, knowledge in the field of Standards, mounting standards and available components of the system is exchanged. Furthermore, trainings include practical part, which demonstrates installation of individual components. Training's aim is to teach how to install properly structured cabling system, which is covered by 25-year warranty for an operation and application of the system.



## ■ Certified Designer

Meetings in design offices allow us to obtain knowledge about the latest investors' requirements and needs. Designers can gather knowledge about the newest Standards, editions and conditions which concern modern structured cabling systems.



## ■ Warranty Program

As our systems meet the highest Standards and requirements, they can work properly for at least 25 years. Each telecommunication system which is designed with the use of FIBRAIN components and installed by Certified Installer can possess warranty program.

## ■ FIBRAINDATA certification procedure

After implementing the installation, Certified Installer is required to submit all the necessary documents, especially as-built documentation, measurement of complete network with the use of authorized device possessing valid calibration term. As a next step, FIBRAIN examines the network and verifies submitted documents. In case of any inaccuracies or mistakes, Certified Installer is required to correct them or complete the documentation. Afterwards, FIBRAIN issues warranty documents, which must be transferred by Certified Installer to the project investor.



### ■ Product warranty

All of the components of Certified FIBRAINDATA System are of the highest quality and free from any material and manufacturing defects.

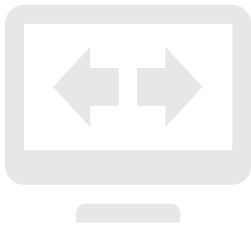

### ■ System warranty

Transmission Channel of the Certified FIBRAINDATA structured cabling system fulfills the parameters according to the given category. The warranty does not cover products which are used, stored or installed improperly.



### ■ Application warranty

FIBRAINDATA Certified structured cabling system is free from defects, which does not enable signal transmission based on specific protocols and network applications. This concerns applications and protocols which are established by the committees for standardization IEEE, ANSI, TIA/EIA, ATM Forum and confirmed for transmission requirements based on TIA/EIA 568-B.2 and/or TIA/EIA 568-A, TIA/EIA568-A-5, ISO-IEC 11801 2nd edition, ISO/IEC 11801, EN 50173 Standards and standards.

## ■ Information materials

Apart from individual meetings, our company has prepared wide range of marketing materials, such as catalogues, publications, technical brochures as well as guides, which have been prepared for a particular group of professionals. Data sheets include all the necessary technical information required for project implementation.

# COPPER



# FIBRAINDATA

## COPPER INSTALLATION CABLES

25-year warranty system guarantees the highest quality

**5e**



SMALL DIAMETER

**PVC  
LSZH**

TWO JACKET TYPES:  
PVC AND LSZH

**U/UTP  
F/UTP**

TWO CONSTRUCTION TYPES:  
U/UTP AND F/UTP

**200  
MHz**

INSTALLATION CABLES- DATA  
TRANSMISSION FREQUENCIES  
UP TO 200 MHz

**6**



CROSSTALKS REDUCTION  
IN U/UTP AND F/UTP  
CONSTRUCTION

**U/UTP U/FTP  
F/UTP F/FTP  
S/FTP**

FULL PORTFOLIO  
OF CABLE CONSTRUCTION

**cat. 6  
X MHz**

MORE THAN  
STANDARD 250 MHz

**FR-LSZH**

S/FTP CABLE ALSO  
IN FLAME RETARDANT  
OPTION

# COPPER INSTALLATION CABLES

and stable connection

**6A**



SEPARATOR WITH ANTY-ALIEN CROSSTALK TECHNOLOGY



SUPPORT FOR WHOLE APPLICATIONS INCLUDING 10GBASE-T AT FULL 100M CHANNEL

**LSZH  
FR-LSZH**

CONDUCTORS IN TWO JACKET TYPES: LSZH OR FR-LSZH

**7A**

900  
1200  
2000  
MHz

TRANSMISSION CHARACTERISTIC  
7-> 900 MHZ 7A->1200 MHZ  
8-> 2000 MHZ

**F/FTP  
S/FTP**

FULL SHIELDED SOLUTION FOR THE HIGHEST PROTECTION AGAINST CROSSTALK

**Voice**

**25  
PAIRS**

ADDITIONAL CONSTRUCTION:  
25 PAIRS IN 1 JACKET

# U/UTP Cat.5e 200 MHz

## Express 5e



### Cable construction

1. Insulation
2. Conductor
3. Jacket

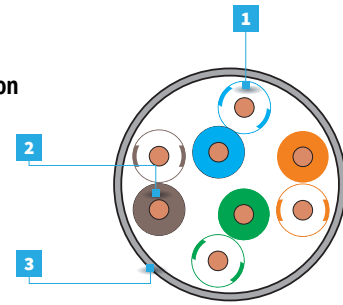

| FIBRAINDATA Express U/UTP Cat.5e 200 MHz |                   |                     |
|--|-------------------|---------------------|
| 305 m box                                | XE100.101         | XE100.105           |
| 500 m drum                               | XE100.102         | XE100.106           |
| 1000 m drum                              | XE100.103         | XE100.107           |
|  | JACKET - GREY PVC | JACKET - GREEN LSZH |

| MECHANICAL CHARACTERISTICS                   |      |
|--|------|
| Min. bending radius in operation [mm]        | 20   |
| Min. bending radius during installation [mm] | 40   |
| Max. pulling tension [N]                     | 80   |
| Nominal weight [kg/km]                       | 29.5 |
| Nom. outer diameter [mm]                     | 5.0  |
| Nom. wire diameter [AWG]                     | 24   |

| ELECTRICAL CHARACTERISTICS @ 20°C                    |                      |
|--|----------------------|
| Max. DC Resistance [ $\Omega$ /km]                   | 93.8                 |
| Nom. Mutual Capacity @1kHz [nF/km]                   | 56                   |
| NVP [%]  | 68                   |
| Mean input Impedance [ $\Omega$ ]                    | 100 $\pm$ 5 @ 100MHz |
| Propagation delay @10MHz [ns]                        | max. 518             |
| Delay Skew [ns/100m]                                 | max. 40              |
| Segregation class                                    | b                    |
| Max. operating voltage [V DC]                        | 80                   |
| Max. DC intensity per conductor [A/mm <sup>2</sup> ] | 3.3                  |

| ENVIRONMENTAL CHARACTERISTICS |                       |
|-------------------------------|-----------------------|
| Jacket material               | PVC                   |
| Flammability                  | Acc. to IEC 60332-1-2 |
| Calorific value [MJ/m]        | 0.377                 |

| Frequency [MHz] | Max. attenuation [dB/100 m] | NEXT           | PS-NEXT | ACR-F | PS-ACR-F | ACR  | PS-ACR | Return loss [dB] |
|-----------------|-----------------------------|----------------|---------|-------|----------|------|--------|------------------|
|                 |                             | [dB/100 m] min |         |       |          |      |        |                  |
| 1               | 2.0                         | 65.3           | 62.3    | 63.8  | 60.8     | 63.3 | 60.3   | 20.0             |
| 4               | 4.1                         | 56.3           | 53.3    | 51.8  | 48.8     | 52.2 | 49.2   | 23.0             |
| 8               | 5.8                         | 51.8           | 48.8    | 45.7  | 42.7     | 46.0 | 43.0   | 24.5             |
| 10              | 6.5                         | 50.3           | 47.3    | 43.8  | 40.8     | 43.8 | 40.8   | 25.0             |
| 16              | 8.2                         | 47.2           | 44.2    | 39.7  | 36.7     | 39.0 | 36.0   | 25.0             |
| 25              | 10.4                        | 44.3           | 41.3    | 35.8  | 32.8     | 33.9 | 30.9   | 24.3             |
| 31.25           | 11.7                        | 42.9           | 39.9    | 33.9  | 30.9     | 31.2 | 28.2   | 23.6             |
| 62.5            | 17.0                        | 38.4           | 35.4    | 27.9  | 24.9     | 21.4 | 18.4   | 21.5             |
| 100             | 22.0                        | 35.3           | 32.3    | 23.8  | 20.8     | 13.3 | 10.3   | 20.1             |
| 125*            | 24.9                        | 33.8           | 30.8    | 21.9  | 18.9     | 9.0  | 6.0    | 19.4             |
| 155*            | 28.1                        | 32.4           | 29.4    | 20.0  | 17.0     | 4.4  | 1.4    | 18.8             |
| 200*            | 32.4                        | 30.8           | 27.8    | 17.8  | 14.8     | ---  | ---    | 18.0             |

### Applications

- 10BASE-T (IEEE 802.3)
- 100BASE-T (IEEE 802.3)
- 1000BASE-T (Gigabit Ethernet)
- 100BASE-VG-AnyLAN
- 100 Mbps TP-PMD (ANSI X3T9.5)
- 4/16 Mbps TOKEN RING (IEEE 802.5) 55/155 Mbps ATM

### Standards

- ISO/IEC 11801
- EN 50173
- TIA 568 C.2
- IEC 61156-5
- EN 50288-3-1
- IEC 60332-1-2

### Construction

- Conductor (wire) - 24 AWG (0.51 mm)
- Insulation - polyolefin
- Pair number - 4 twisted pairs
- Jacket - grey PVC
- Jacket - green LSZH

### TEMPERATURE CHARACTERISTICS

|                            |            |
|----------------------------|------------|
| Storage Temperature [°C]   | -20 to +70 |
| Operating Temperature [°C] | -20 to +70 |
| During installation [°C]   | -5° to +50 |

\*for information only

# F/UTP Cat.5e 200 MHz

## Express 5e



### Cable construction

1. Insulation
2. Drain wire
3. Conductor
4. Aluminium foil
5. Jacket

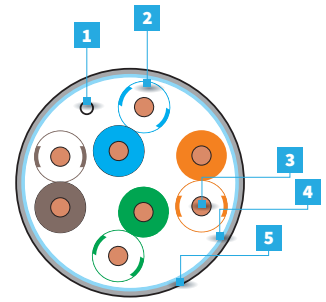

| FIBRAINDATA Express F/UTP Cat.5e 200 MHz |                   |                     |
|--|-------------------|---------------------|
| 305 m box                                | XE100.111         | XE100.115           |
| 500 m drum                               | XE100.112         | XE100.116           |
| 1000 m drum                              | XE100.113         | XE100.117           |
|  | JACKET - GREY PVC | JACKET - GREEN LSZH |

| MECHANICAL CHARACTERISTICS                   |     |
|--|-----|
| Min. bending radius in operation [mm]        | 25  |
| Min. bending radius during installation [mm] | 45  |
| Max. pulling tension [N]                     | 80  |
| Nominal weight [kg/km]                       | 36  |
| Nom. outer diameter [mm]                     | 5.6 |
| Nom. wire diameter [AWG]                     | 24  |

| ELECTRICAL CHARACTERISTICS @ 20°C                    |                      |
|--|----------------------|
| Max. DC Resistance [ $\Omega$ /km]                   | 95                   |
| Nom. Mutual Capacity @1kHz [nF/km]                   | 56                   |
| NVP [%]  | 68                   |
| Mean input Impedance [ $\Omega$ ]                    | 100 $\pm$ 5 @ 100MHz |
| Propagation delay @10MHz [ns]                        | max. 518             |
| Delay Skew [ns/100m]                                 | max. 40              |
| Segregation class                                    | c                    |
| Max. operating voltage [V DC]                        | 80                   |
| Max. DC intensity per conductor [A/mm <sup>2</sup> ] | 3.3                  |

| ENVIRONMENTAL CHARACTERISTICS |                       |
|-------------------------------|-----------------------|
| Jacket material               | PVC                   |
| Flammability                  | Acc. to IEC 60332-1-2 |
| Calorific value [MJ/m]        | 0.464                 |

| Frequency [MHz] | Max. attenuation [dB/100 m] | NEXT           | PS-NEXT | ACR-F | PS-ACR-F | ACR  | PS-ACR | Return loss [dB] |
|-----------------|-----------------------------|----------------|---------|-------|----------|------|--------|------------------|
|                 |                             | [dB/100 m] min |         |       |          |      |        |                  |
| 1               | 2.1                         | 65.3           | 62.3    | 64.0  | 61.0     | 63.2 | 60.3   | 20.0             |
| 4               | 4.0                         | 56.3           | 53.3    | 52.0  | 49.0     | 52.3 | 49.3   | 23.0             |
| 8               | 5.6                         | 51.8           | 48.8    | 45.9  | 42.9     | 46.1 | 43.1   | 24.5             |
| 10              | 6.3                         | 50.3           | 47.3    | 44.0  | 41.0     | 44.0 | 41.0   | 25.0             |
| 16              | 8.0                         | 47.2           | 44.2    | 39.9  | 36.9     | 39.2 | 36.2   | 25.0             |
| 25              | 10.1                        | 44.3           | 41.3    | 36.0  | 33.0     | 34.2 | 31.2   | 24.3             |
| 31.25           | 11.4                        | 42.9           | 39.9    | 34.1  | 31.1     | 31.5 | 28.5   | 23.6             |
| 62.5            | 16.5                        | 38.4           | 35.4    | 28.1  | 25.1     | 21.9 | 18.9   | 21.5             |
| 100             | 21.3                        | 35.3           | 32.3    | 24.0  | 21.0     | 14.0 | 11.0   | 20.1             |
| 125*            | 24.1                        | 33.8           | 30.8    | 22.1  | 19.1     | 9.7  | 6.7    | 19.4             |
| 155*            | 27.2                        | 32.4           | 29.4    | 20.2  | 17.2     | 5.2  | 2.2    | 18.8             |
| 200*            | 31.4                        | 30.8           | 27.8    | 18.0  | 15.0     | ---  | ---    | 18.0             |

- ### Applications
- 10BASE-T (IEEE 802.3)
  - 100BASE-T (IEEE 802.3)
  - 1000BASE-T (Gigabit Ethernet)
  - 100BASE-VG-AnyLAN
  - 100 Mbps TP-PMD (ANSI X3T9.5)
  - 4/16 Mbps TOKEN RING (IEEE 802.5) 55/155 Mbps ATM

### Standards

- ISO/IEC 11801
- EN 50173
- IEC 61156-5
- EN 50288-3-1
- IEC 60332-1-2

### Construction

- Conductor (wire) - 24 AWG 0.51 mm
- Insulation - polyolefin
- Pair number- 4 twisted pairs
- Shield - aluminium foil/polyester around all pairs
- Grounding - galvanized copper wire ,  $\Phi$ 0.4 mm
- Jacket - grey PVC
- Jacket - green LSZH

### TEMPERATURE CHARACTERISTICS

|                            |            |
|----------------------------|------------|
| Storage Temperature [°C]   | -20 to +70 |
| Operating Temperature [°C] | -20 to +70 |
| During installation [°C]   | -5° to +50 |

\*for information only

# U/UTP Cat.6 500 MHz

## Quick 6



### Cable construction

1. Conductor
2. Insulation
3. Twisted wires
4. Cross web
5. Jacket

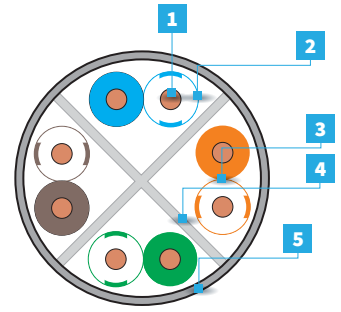

| FIBRAINDATA Quick U/UTP Cat.6 500 MHz |                   |                    |
|---------------------------------------|-------------------|--------------------|
| 305 m box                             | XQ100.101         | XQ100.105          |
| 500 m drum                            | XQ100.102         | XQ100.106          |
| 1000 m drum                           | XQ100.103         | XQ100.107          |
|                                       | JACKET - PVC GREY | JACKET - LSZH BLUE |

| MECHANICAL CHARACTERISTICS                   |      |
|--|------|
| Min. bending radius in operation [mm]        | 20   |
| Min. bending radius during installation [mm] | 45   |
| Max. pulling tension [N]                     | 95   |
| Nominal weight [kg/km]                       | 36.3 |
| Nom. outer diameter [mm]                     | 5.4  |
| Nom. wire diameter [AWG]                     | 24   |

| ELECTRICAL CHARACTERISTICS @ 20°C                    |                      |
|--|----------------------|
| Max. DC Resistance [ $\Omega$ /km]                   | 93.8                 |
| Nom. Mutual Capacity @1kHz [nF/km]                   | 56                   |
| NVP [%]  | 68                   |
| Mean input Impedance [ $\Omega$ ]                    | 100 $\pm$ 5 @ 100MHz |
| Propagation delay @10MHz [ns]                        | max. 518             |
| Delay Skew [ns/100m]                                 | max. 40              |
| Segregation class                                    | b                    |
| Max. operating voltage [V DC]                        | 80                   |
| Max. DC intensity per conductor [A/mm <sup>2</sup> ] | 3.3                  |

| ENVIRONMENTAL CHARACTERISTICS |                       |
|-------------------------------|-----------------------|
| Jacket material               | PVC                   |
| Flammability                  | Acc. to IEC 60332-1-2 |
| Calorific value [MJ/m]        | 0.52                  |

| Frequency [MHz] | Max. attenuation [dB/100 m] | NEXT           | PS-NEXT | ACR-F | PS-ACR-F | ACR  | PS-ACR | Return loss [dB] |
|-----------------|-----------------------------|----------------|---------|-------|----------|------|--------|------------------|
|                 |                             | [dB/100 m] min |         |       |          |      |        |                  |
| 1               | 2.0                         | 75.3           | 72.3    | 68.0  | 65.0     | 73.2 | 70.2   | 20.0             |
| 4               | 3.8                         | 66.3           | 63.3    | 58.0  | 55.0     | 62.5 | 59.5   | 23.0             |
| 8               | 5.2                         | 61.8           | 58.8    | 51.9  | 48.9     | 56.5 | 53.5   | 24.5             |
| 10              | 5.9                         | 60.3           | 57.3    | 50.0  | 47.0     | 54.4 | 51.4   | 25.0             |
| 16              | 7.4                         | 57.2           | 54.2    | 45.9  | 42.9     | 49.9 | 46.9   | 25.0             |
| 25              | 9.2                         | 54.3           | 51.3    | 42.0  | 39.0     | 45.0 | 42.0   | 24.3             |
| 31.25           | 10.3                        | 52.9           | 49.9    | 40.1  | 37.1     | 42.6 | 39.6   | 23.6             |
| 62.5            | 14.5                        | 48.4           | 45.4    | 34.1  | 31.1     | 33.8 | 30.8   | 21.5             |
| 100             | 18.4                        | 45.3           | 42.3    | 30.0  | 27.0     | 26.9 | 23.9   | 20.1             |
| 155             | 22.9                        | 42.4           | 39.4    | 26.2  | 23.2     | 19.5 | 16.5   | 18.8             |
| 200             | 26.1                        | 40.8           | 37.8    | 24.0  | 21.0     | 14.7 | 11.7   | 18.0             |
| 250             | 29.2                        | 39.3           | 36.3    | 22.0  | 19.0     | 10.1 | 7.1    | 17.3             |
| 300*            | 32.0                        | 38.1           | 35.1    | 20.5  | 17.5     | 6.1  | 3.1    | 17.3             |
| 350*            | 34.7                        | 37.1           | 34.1    | 19.1  | 16.1     | 2.5  | 1.0    | 17.3             |
| 500*            | 48.9                        | 34.8           | 31.8    | 16.0  | 13.0     | 0.0  | ---    | 15.0             |

## Copper cabling

- ### Applications
- 10BASE-T (IEEE 802.3)
  - 100BASE-T (IEEE 802.3)
  - 1000BASE-T (Gigabit Ethernet)
  - 100BASE-VG-AnyLAN
  - 100 Mbps TP-PMD (ANSI X3T9.5)
  - 4/16 Mbps TOKEN RING (IEEE 802.5) 55/155 Mbps ATM

### Standards

- ISO/IEC 11801
- EN 50173
- TIA 568 C.2
- IEC 61156-5
- EN 50288-3-1
- IEC 60332-1-2

### Construction

- Conductor (wire) - 24 AWG (0.51 mm)
- Insulation - polyolefin
- Pair number - 4 twisted pairs
- Jacket - grey PVC
- Jacket - green LSZH

### TEMPERATURE CHARACTERISTICS

|                            |            |
|----------------------------|------------|
| Storage Temperature [°C]   | -20 to +70 |
| Operating Temperature [°C] | -20 to +70 |
| During installation [°C]   | -5° to +50 |

\*for information only

# F/UTP Cat.6 350 MHz

## Quick 6



### Cable construction

1. Insulation
2. Conductor
3. Aluminium foil
4. Drain wire
5. Cross web
6. Jacket

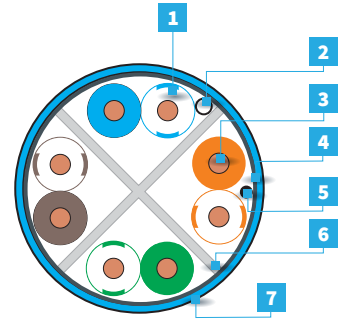

### FIBRAINDATA Quick F/UTP Cat.6 Jacket LSZH 350 MHz

|                           |           |
|---------------------------|-----------|
| 500 m drum                | XQ100.116 |
| 1000 m drum               | XQ100.117 |
| <b>JACKET - LSZH BLUE</b> |           |

### MECHANICAL CHARACTERISTICS

|  |      |
|--|------|
| Min. bending radius in operation [mm]        | 25   |
| Min. bending radius during installation [mm] | 45   |
| Max. pulling tension [N]                     | 80   |
| Nominal weight [kg/km]                       | 45.0 |
| Nom. outer diameter [mm]                     | 6.9  |
| Nom. wire diameter [AWG]                     | 23   |

### ELECTRICAL CHARACTERISTICS @ 20°C

|  |                      |
|--|----------------------|
| Max. DC Resistance [ $\Omega$ /km]                   | 95.0                 |
| Nom. Mutual Capacity @1kHz [nF/km]                   | 56                   |
| NVP [%]  | 70                   |
| Mean input Impedance [ $\Omega$ ]                    | 100 $\pm$ 5 @ 100MHz |
| Propagation delay @10MHz [ns]                        | max. 518             |
| Delay Skew [ns/100m]                                 | max. 40              |
| Segregation class                                    | c                    |
| Max. operating voltage [V DC]                        | 80                   |
| Max. DC intensity per conductor [A/mm <sup>2</sup> ] | 3.3                  |

### ENVIRONMENTAL CHARACTERISTICS

|                        |   |
|------------------------|---|
| Jacket material        | LSZH  |
| Flammability           | Acc. to IEC 60332-1-2; IEC 60754-1/2; IEC 61034-1/2 |
| Calorific value [MJ/m] | 0.868   |

| Frequency [MHz] | Max. attenuation [dB/100 m] | NEXT           | PS-NEXT | ACR-F | PS-ACR-F | ACR  | PS-ACR | Return loss [dB] |
|-----------------|-----------------------------|----------------|---------|-------|----------|------|--------|------------------|
|                 |                             | [dB/100 m] min |         |       |          |      |        |                  |
| 1*              | 2.1                         | 75.3           | 72.3    | 68.0  | 65.0     | 73.2 | 70.2   | 20.0             |
| 4               | 3.8                         | 66.3           | 63.3    | 58.0  | 55.0     | 62.5 | 59.5   | 23.0             |
| 8               | 5.2                         | 61.8           | 58.8    | 51.9  | 48.9     | 56.5 | 53.5   | 24.5             |
| 10              | 5.9                         | 60.3           | 57.3    | 50.0  | 47.0     | 54.4 | 51.4   | 25.0             |
| 16              | 7.4                         | 57.2           | 54.2    | 45.9  | 42.9     | 49.9 | 46.9   | 25.0             |
| 25              | 9.2                         | 54.3           | 51.3    | 42.0  | 39.0     | 45.0 | 42.0   | 24.3             |
| 31.25           | 10.3                        | 52.9           | 49.9    | 40.1  | 37.1     | 42.6 | 39.6   | 23.6             |
| 62.5            | 14.5                        | 48.4           | 45.4    | 34.1  | 31.1     | 33.8 | 30.8   | 21.5             |
| 100             | 18.4                        | 45.3           | 42.3    | 30.0  | 27.0     | 26.9 | 23.9   | 20.1             |
| 155             | 22.9                        | 42.4           | 39.4    | 26.2  | 23.2     | 19.5 | 16.5   | 18.8             |
| 200             | 26.1                        | 40.8           | 37.8    | 24.0  | 21.0     | 14.7 | 11.7   | 18.0             |
| 250             | 29.2                        | 39.3           | 36.3    | 22.0  | 19.0     | 10.1 | 7.1    | 17.3             |
| 300*            | 32.0                        | 38.1           | 35.1    | 20.5  | 17.5     | 6.1  | 3.1    | 17.3             |
| 350*            | 34.7                        | 37.1           | 34.1    | 19.1  | 16.1     | 2.5  | 1.0    | 17.3             |

## Twisted pair Installation Cables

### Applications

- 10BASE-T (IEEE 802.3)
- 100BASE-T (IEEE 802.3)
- 1000BASE-T (Gigabit Ethernet)
- 100BASE-VG-AnyLAN
- 100 Mbps TP-PMD (ANSI X3T9.5)
- 4/16 Mbps TOKEN RING (IEEE 802.5) 55/155 Mbps ATM

### Standards

- ISO/IEC 11801
- EN 50173
- IEC 61156-5
- EN 50288-2-1
- IEC 60332-1-2
- IEC 60754-1/2
- IEC 61034-1/2

### Construction

- Conductor (wire) - 23 AWG (0.574 mm)
- Insulation: polyolefin
- Pair number: 4 twisted pairs
- Jacket: blue LSZH in accordance with IEC 60322-1
- Shield - aluminium foil/polyester around all pairs
- Grounding: galvanized copper wire  $\Phi$ 0.4 mm

### TEMPERATURE CHARACTERISTICS

|                            |            |
|----------------------------|------------|
| Storage Temperature [°C]   | -20 to +70 |
| Operating Temperature [°C] | -20 to +70 |
| During installation [°C]   | -5° to +50 |

\*for information

# U/FTP Cat.6 450 MHz

## Quick 6



### Copper cabling

#### Cable construction

1. Insulation
2. Drain wire
3. Conductor
4. Aluminium foil
5. Jacket

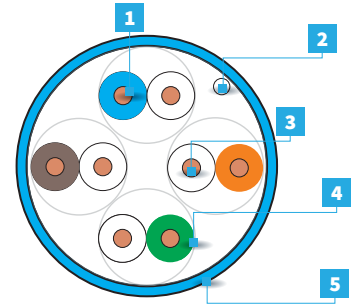

| FIBRAINDATA Quick U/FTP Cat.6 Jacket LSZH 450 MHz |           |
|---|-----------|
| 500 m drum  | XQ100.126 |
| 1000 m drum                                       | XQ100.127 |
| <b>JACKET - LSZH BLUE</b>                         |           |

| MECHANICAL CHARACTERISTICS                           |   |
|--|---|
| Min. bending radius in operation [mm]                | 30  |
| Min. bending radius during installation [mm]         | 60  |
| Max. pulling tension [N]                             | 95  |
| Nominal weight [kg/km]                               | 51.0  |
| Nom. outer diameter [mm]                             | 7.4   |
| Nom. wire diameter [AWG]                             | 23  |
| ELECTRICAL CHARACTERISTICS @ 20°C                    |   |
| Max. DC Resistance [ $\Omega$ /km]                   | 95.0  |
| Nom. Mutual Capacity @1kHz [nF/km]                   | 56  |
| NVP [%]  | 74  |
| Mean input Impedance [ $\Omega$ ]                    | 100 $\pm$ 5 @ 100MHz                                |
| Propagation delay @10MHz [ns]                        | max. 518  |
| Delay Skew [ns/100m]                                 | max. 40   |
| Segregation class                                    | c   |
| Max. operating voltage [V DC]                        | 80  |
| Max. DC intensity per conductor [A/mm <sup>2</sup> ] | 3.3   |
| ENVIRONMENTAL CHARACTERISTICS                        |   |
| Jacket material                                      | LSZH  |
| Flammability   | Acc. to IEC 60332-1-2, IEC 60754-1/2; IEC 61034-1/2 |
| Calorific value [MJ/m]                               | 0.687   |

| Frequency [MHz] | Max. attenuation [dB/100 m] | NEXT           | PS-NEXT | ACR-F | PS-ACR-F | ACR  | PS-ACR | Return loss [dB] |
|-----------------|-----------------------------|----------------|---------|-------|----------|------|--------|------------------|
|                 |                             | [dB/100 m] min |         |       |          |      |        |                  |
| 1               | 2.0                         | 75.3           | 72.3    | 68.0  | 65.0     | 73.2 | 70.2   | 20.0             |
| 4               | 3.8                         | 66.3           | 63.3    | 58.0  | 55.0     | 62.5 | 59.5   | 23.0             |
| 8               | 5.2                         | 61.8           | 58.8    | 51.9  | 48.9     | 56.5 | 53.5   | 24.5             |
| 10              | 5.9                         | 60.3           | 57.3    | 50.0  | 47.0     | 54.4 | 51.4   | 25.0             |
| 16              | 7.4                         | 57.2           | 54.2    | 45.9  | 42.9     | 49.9 | 46.9   | 25.0             |
| 25              | 9.2                         | 54.3           | 51.3    | 42.0  | 39.0     | 45.0 | 42.0   | 24.3             |
| 31.25           | 10.3                        | 52.9           | 49.9    | 40.1  | 37.1     | 42.6 | 39.6   | 23.6             |
| 62.5            | 14.5                        | 48.4           | 45.4    | 34.1  | 31.1     | 33.8 | 30.8   | 21.5             |
| 100             | 18.4                        | 45.3           | 42.3    | 30.0  | 27.0     | 26.9 | 23.9   | 20.1             |
| 155             | 22.9                        | 42.4           | 39.4    | 26.2  | 23.2     | 19.5 | 16.5   | 18.8             |
| 200             | 26.1                        | 40.8           | 37.8    | 24.0  | 21.0     | 14.7 | 11.7   | 18.0             |
| 250             | 29.2                        | 39.3           | 36.3    | 22.0  | 19.0     | 10.1 | 7.1    | 17.3             |
| 300*            | 32.0                        | 38.1           | 35.1    | 20.5  | 17.5     | 6.1  | 3.1    | 17.3             |
| 350*            | 34.7                        | 37.1           | 34.1    | 19.1  | 16.1     | 2.5  | 1.0    | 17.3             |
| 450*            | 39.5                        | 35.5           | 32.5    | 16.9  | 13.9     | 1.0  | ---    | 16.0             |

\*for information only

- #### Applications
- 10BASE-T (IEEE 802.3)
  - 100BASE-T (IEEE 802.3)
  - 1000BASE-T (Gigabit Ethernet)
  - 100BASE-VG-AnyLAN
  - 100 Mbps TP-PMD (ANSI X3T9.5)
  - 4/16 Mbps TOKEN RING (IEEE 802.5) 55/155 Mbps ATM

- #### Standards
- ISO/IEC 11801
  - EN 50173
  - IEC 61156-5
  - EN 50288-3-1
  - IEC 60332-1-2
  - IEC 60754-1/2
  - IEC 61034-1/2

- #### Construction
- Conductor (wire) - 23 AWG (0.574 mm)
  - Insulation: polyolefin
  - Pair number: 4 twisted pairs
  - Jacket: blue LSZH in accordance with IEC 60322-1
  - Shield: aluminium/polyester foil around each pair
  - Grounding: galvanized copper wire  $\Phi$ 0.4 mm

#### TEMPERATURE CHARACTERISTICS

|                            |            |
|----------------------------|------------|
| Storage Temperature [°C]   | -20 to +70 |
| Operating Temperature [°C] | -20 to +70 |
| During installation [°C]   | -5° to +50 |



# F/FTP Cat.6 450 MHz

## Quick 6



### Cable construction

1. Insulation
2. Drain wire
3. Conductor
4. Aluminium foil
5. Jacket

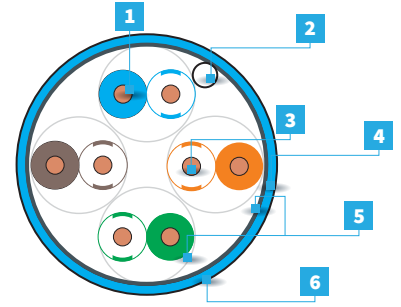

| FIBRAINDATA Quick F/FTP Cat.6 Jacket LSZH 450 MHz |           |
|---|-----------|
| 500 m drum  | XQ100.136 |
| 1000 m drum                                       | XQ100.137 |
| <b>JACKET - LSZH BLUE</b>                         |           |

| MECHANICAL CHARACTERISTICS                           |   |
|--|---|
| Min. bending radius in operation [mm]                | 30  |
| Min. bending radius during installation [mm]         | 60  |
| Max. pulling tension [N]                             | 95  |
| Nominal weight [kg/km]                               | 53.4  |
| Nom. outer diameter [mm]                             | 7.5   |
| Nom. wire diameter [AWG]                             | 23  |
| ELECTRICAL CHARACTERISTICS @ 20°C                    |   |
| Max. DC Resistance [ $\Omega$ /km]                   | 95.0  |
| Nom. Mutual Capacity @1kHz [nF/km]                   | 56  |
| NVP [%]  | 74  |
| Mean input Impedance [ $\Omega$ ]                    | 100 $\pm$ 5 @ 100MHz                                |
| Propagation delay @10MHz [ns]                        | max. 518  |
| Delay Skew [ns/100m]                                 | max. 40   |
| Segregation class                                    | c   |
| Max. operating voltage [V DC]                        | 80  |
| Max. DC intensity per conductor [A/mm <sup>2</sup> ] | 3.3   |
| ENVIRONMENTAL CHARACTERISTICS                        |   |
| Jacket material                                      | LSZH  |
| Flammability   | Acc. to IEC 60332-1-2, IEC 60754-1/2; IEC 61034-1/2 |
| Calorific value [MJ/m]                               | 0.696   |

| Frequency [MHz] | Max. attenuation [dB/100 m] | NEXT           | PS-NEXT | ACR-F | PS-ACR-F | ACR  | PS-ACR | Return loss [dB] |
|-----------------|-----------------------------|----------------|---------|-------|----------|------|--------|------------------|
|                 |                             | [dB/100 m] min |         |       |          |      |        |                  |
| 1               | 2.1                         | 75.3           | 72.3    | 68.0  | 65.0     | 73.2 | 70.2   | 20.0             |
| 4               | 3.8                         | 66.3           | 63.3    | 58.0  | 55.0     | 62.5 | 59.5   | 23.0             |
| 8               | 5.2                         | 61.8           | 58.8    | 51.9  | 48.9     | 56.5 | 53.5   | 24.5             |
| 10              | 5.9                         | 60.3           | 57.3    | 50.0  | 47.0     | 54.4 | 51.4   | 25.0             |
| 16              | 7.4                         | 57.2           | 54.2    | 45.9  | 42.9     | 49.9 | 46.9   | 25.0             |
| 25              | 9.2                         | 54.3           | 51.3    | 42.0  | 39.0     | 45.0 | 42.0   | 24.3             |
| 31.25           | 10.3                        | 52.9           | 49.9    | 40.1  | 37.1     | 42.6 | 39.6   | 23.6             |
| 62.5            | 14.5                        | 48.4           | 45.4    | 34.1  | 31.1     | 33.8 | 30.8   | 21.5             |
| 100             | 18.4                        | 45.3           | 42.3    | 30.0  | 27.0     | 26.9 | 23.9   | 20.1             |
| 155             | 22.9                        | 42.4           | 39.4    | 26.2  | 23.2     | 19.5 | 16.5   | 18.8             |
| 200             | 26.1                        | 40.8           | 37.8    | 24.0  | 21.0     | 14.7 | 11.7   | 18.0             |
| 250             | 29.2                        | 39.3           | 36.3    | 22.0  | 19.0     | 10.1 | 7.1    | 17.3             |
| 300*            | 32.0                        | 38.1           | 35.1    | 20.5  | 17.5     | 6.1  | 3.1    | 17.3             |
| 350*            | 34.7                        | 37.1           | 34.1    | 19.1  | 16.1     | 2.5  | 1.0    | 17.3             |
| 450*            | 39.5                        | 35.5           | 32.5    | 16.9  | 13.9     | 1.0  | ---    | 16.0             |

- ### Applications
- 10BASE-T (IEEE 802.3)
  - 100BASE-T (IEEE 802.3)
  - 1000BASE-T (Gigabit Ethernet)
  - 100BASE-VG-AnyLAN
  - 100 Mbps TP-PMD (ANSI X3T9.5)
  - 4/16 Mbps TOKEN RING (IEEE 802.5) 55/155 Mbps ATM

- ### Standards
- ISO/IEC 11801
  - EN 50173
  - IEC 61156-5
  - EN 50288-3-1
  - IEC 60332-1-2
  - IEC 60754-1/2
  - IEC 61034-1/2

- ### Construction
- Conductor (wire) - 23 AWG (0.574 mm)
  - Insulation: polyolefin
  - Pair number: 4 twisted pairs
  - Jacket: blue LSZH in accordance with IEC 60322-1
  - Shield: aluminium/polyester foil around each pair
  - Shield: aluminium/polyester foil around all pairs
  - Grounding: galvanized copper wire  $\Phi$ 0.4 mm

| TEMPERATURE CHARACTERISTICS |            |
|-----------------------------|------------|
| Storage Temperature [°C]    | -20 to +70 |
| Operating Temperature [°C]  | -20 to +70 |
| During installation [°C]    | -5° to +50 |

\*for information only

# F/UTP Cat.6<sub>A</sub> 500 MHz

## Rapid 6a



### Cable construction

1. Insulation
2. Conductor
3. Shield
4. Drain wire
5. Cross web
6. Jacket

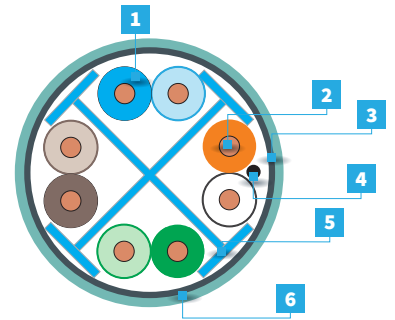

| FIBRAINDATA Rapid F/UTP Cat.6 <sub>A</sub> Jacket LSZH 500 MHz |           |
|--|-----------|
| 500 m drum   | XR100.116 |
| 1000 m drum  | XR100.117 |
| <b>JACKET - LSZH AQUA</b>                                      |           |

| MECHANICAL CHARACTERISTICS                   |      |
|--|------|
| Min. bending radius in operation [mm]        | 35   |
| Min. bending radius during installation [mm] | 65   |
| Max. pulling tension [N]                     | 90   |
| Nominal weight [kg/km]                       | 52.6 |
| Nom. outer diameter [mm]                     | 7.6  |
| Nom. wire diameter [AWG]                     | 23   |

| ELECTRICAL CHARACTERISTICS @ 20°C                    |                  |
|--|------------------|
| Max. DC Resistance [Ω/km]                            | 95.0             |
| Nom. Mutual Capacity @1kHz [nF/km]                   | 56               |
| NVP [%]  | 72               |
| Mean input Impedance [Ω]                             | 100 ± 5 @ 100MHz |
| Propagation delay @10MHz [ns]                        | max. 518         |
| Delay Skew [ns/100m]                                 | max. 40          |
| Segregation class                                    | c                |
| Max. operating voltage [V DC]                        | 80               |
| Max. DC intensity per conductor [A/mm <sup>2</sup> ] | 3.3              |

| ENVIRONMENTAL CHARACTERISTICS |   |
|-------------------------------|---|
| Jacket material               | LSZH  |
| Flammability                  | Acc. to IEC 60332-1-2; IEC 60754-1/2; IEC 61034-1/2 |
| Calorific value [MJ/m]        | 0.717   |

| Frequency [MHz] | Max. attenuation [dB/100 m] | NEXT           | PS-NEXT | ACR-F | PS-ACR-F | ACR  | PS-ACR | Return loss [dB] |
|-----------------|-----------------------------|----------------|---------|-------|----------|------|--------|------------------|
|                 |                             | [dB/100 m] min |         |       |          |      |        |                  |
| 1*              | 2.1                         | 75.3           | 72.3    | 68.0  | 65.0     | 73.2 | 70.2   | 20.0             |
| 4               | 3.8                         | 66.3           | 63.3    | 56.0  | 53.0     | 62.5 | 59.5   | 23.0             |
| 8               | 5.3                         | 61.8           | 58.8    | 69.9  | 46.9     | 56.4 | 53.4   | 24.5             |
| 10              | 5.9                         | 60.3           | 57.3    | 48.0  | 45.0     | 54.4 | 51.4   | 25.0             |
| 16              | 7.5                         | 57.2           | 54.2    | 43.9  | 40.9     | 49.8 | 46.8   | 25.0             |
| 25              | 9.4                         | 54.3           | 51.3    | 40.0  | 37.0     | 45.0 | 42.0   | 24.3             |
| 31.25           | 10.5                        | 52.9           | 49.9    | 38.1  | 35.1     | 42.4 | 39.4   | 23.6             |
| 62.5            | 15.0                        | 48.4           | 45.4    | 32.1  | 29.1     | 33.4 | 30.4   | 21.5             |
| 100             | 19.0                        | 45.3           | 42.3    | 28.0  | 25.0     | 26.2 | 23.2   | 20.1             |
| 155             | 24.1                        | 42.4           | 39.4    | 24.2  | 21.2     | 18.4 | 15.4   | 18.8             |
| 200             | 27.6                        | 40.8           | 37.8    | 22.0  | 19.0     | 13.2 | 10.2   | 18.0             |
| 250             | 31.1                        | 39.3           | 36.3    | 20.0  | 17.0     | 8.3  | 5.3    | 17.3             |
| 300             | 34.3                        | 38.1           | 35.1    | 18.5  | 15.5     | 3.9  | 0.9    | 17.3             |
| 350             | 37.2                        | 37.1           | 34.1    | 17.1  | 14.1     | ---  | ---    | 17.3             |
| 400             | 40.1                        | 36.3           | 33.3    | 16.0  | ---      | ---  | ---    | 17.3             |
| 500             | 45.3                        | 34.8           | 31.8    | 14.0  | ---      | ---  | ---    | 17.3             |

## Copper cabling

### Applications

- 10BASE-T (IEEE 802.3)
- 100BASE-T (IEEE 802.3)
- 1000BASE-T (Gigabit Ethernet)
- 10GBASE-T (10Gigabit Ethernet)
- 100 Mbps TP-PMD (ANSI X3T9.5)
- 4/16 Mbps TOKEN RING (IEEE 802.5) 55/155 Mbps ATM

### Standards

- ISO/IEC 11801
- EN 50173
- IEC 61156-5
- EN 50288-2-1
- IEC 60332-1-2
- IEC 60754-1/2
- IEC 61034-1/2

### Construction

- Conductor (wire) - 23 AWG (0.574 mm)
- Insulation: polyolefin
- Pair number: 4 twisted pairs
- Jacket: LSZH aqua in accordance with IEC 60322-1
- Shield: Aluminium foil/polyester around all pairs
- Grounding: galvanized copper wire Ø0.4 mm

### TEMPERATURE CHARACTERISTICS [°C]

|                     |              |
|---------------------|--------------|
| Storage             | -20° to +70° |
| Operating           | -20° to +70° |
| During installation | -5° to +50°  |

\*for information only

# U/FTP Cat.6<sub>A</sub> 500 MHz

## Rapid 6a

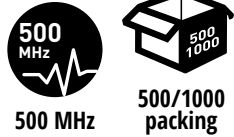

### Cable construction

1. Insulation
2. Drain wire
3. Conductor
4. Aluminium foil
5. Jacket

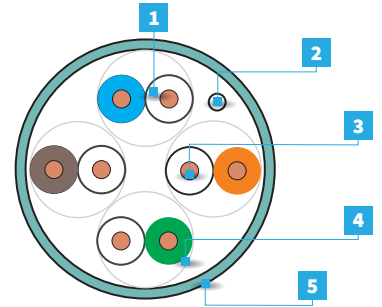

| FIBRAINDATA Rapid U/FTP Cat.6 <sub>A</sub> Jacket LSZH 500 MHz |           |
|--|-----------|
| 500 m reel   | XR100.126 |
| 1000 m reel  | XR100.127 |
| <b>JACKET - LSZH AQUA</b>                                      |           |

| MECHANICAL CHARACTERISTICS                           |   |
|--|---|
| Min. bending radius in operation [mm]                | 30  |
| Min. bending radius during installation [mm]         | 60  |
| Max. pulling tension [N]                             | 95  |
| Nominal weight [kg/km]                               | 51.0  |
| Nom. outer diameter [mm]                             | 7.4   |
| Nom. wire diameter [AWG]                             | 23  |
| ELECTRICAL CHARACTERISTICS @ 20°C                    |   |
| Max. DC Resistance [Ω/km]                            | 95.0  |
| Nom. Mutual Capacity @1kHz [nF/km]                   | 56  |
| NVP [%]  | 74  |
| Mean input Impedance [Ω]                             | 100 ± 5 @ 100MHz                                    |
| Propagation delay @10MHz [ns]                        | max. 518  |
| Delay Skew [ns/100m]                                 | max. 40   |
| Segregation class                                    | c   |
| Max. operating voltage [V DC]                        | 80  |
| Max. DC intensity per conductor [A/mm <sup>2</sup> ] | 3.3   |
| ENVIRONMENTAL CHARACTERISTICS                        |   |
| Jacket material                                      | LSZH  |
| Flammability   | Acc. to IEC 60332-1-2; IEC 60754-1/2; IEC 61034-1/2 |
| Caloric value [MJ/m]                                 | 0.687   |

| Frequency [MHz] | Max. attenuation [dB/100 m] | NEXT           | PS-NEXT | ACR-F | PS-ACR-F | ACR  | PS-ACR | Return loss [dB] |
|-----------------|-----------------------------|----------------|---------|-------|----------|------|--------|------------------|
|                 |                             | [dB/100 m] min |         |       |          |      |        |                  |
| 1               | 2.0                         | 75.3           | 72.3    | 68.0  | 65.0     | 73.2 | 70.2   | 20.0             |
| 4               | 3.8                         | 66.3           | 63.3    | 58.0  | 55.0     | 62.5 | 59.5   | 23.0             |
| 8               | 5.2                         | 61.8           | 58.8    | 51.9  | 48.9     | 56.5 | 53.5   | 24.5             |
| 10              | 5.9                         | 60.3           | 57.3    | 50.0  | 47.0     | 54.4 | 51.4   | 25.0             |
| 16              | 7.4                         | 57.2           | 54.2    | 45.9  | 42.9     | 49.9 | 46.9   | 25.0             |
| 25              | 9.2                         | 54.3           | 51.3    | 42.0  | 39.0     | 45.0 | 42.0   | 24.3             |
| 31.25           | 10.3                        | 52.9           | 49.9    | 40.1  | 37.1     | 42.6 | 39.6   | 23.6             |
| 62.5            | 14.5                        | 48.4           | 45.4    | 34.1  | 31.1     | 33.8 | 30.8   | 21.5             |
| 100             | 18.4                        | 45.3           | 42.3    | 30.0  | 27.0     | 26.9 | 23.9   | 20.1             |
| 155             | 22.9                        | 42.4           | 39.4    | 26.2  | 23.2     | 19.5 | 16.5   | 18.8             |
| 200             | 26.1                        | 40.8           | 37.8    | 24.0  | 21.0     | 14.7 | 11.7   | 18.0             |
| 250             | 29.2                        | 39.3           | 36.3    | 22.0  | 19.0     | 10.1 | 7.1    | 17.3             |
| 300*            | 32.0                        | 38.1           | 35.1    | 20.5  | 17.5     | 6.1  | 3.1    | 17.3             |
| 350*            | 34.7                        | 37.1           | 34.1    | 19.1  | 16.1     | 2.5  | 1.0    | 17.3             |
| 450*            | 39.5                        | 35.5           | 32.5    | 16.9  | 13.9     | 1.0  | ---    | 16.0             |

\*for information only

**Applications**

- 10BASE-T (IEEE 802.3)
- 100BASE-T (IEEE 802.3)
- 1000BASE-T (Gigabit Ethernet)
- 100BASE-VG-AnyLAN
- 100 Mbps TP-PMD (ANSI X3T9.5)
- 4/16 Mbps TOKEN RING (IEEE 802.5) 55/155 Mbps ATM

**Standards**

- ISO/IEC 11801
- EN 50173
- IEC 61156-5
- EN 50288-3-1
- IEC 60332-1-2
- IEC 60754-1/2
- IEC 61034-1/2

**Construction**

- Conductor (wire) - 23 AWG (0.574 mm)
- Insulation: polyolefin
- Pair number: 4 twisted pairs
- Jacket: LSZH aqua in accordance with IEC 60332-1
- Shield: aluminium/polyester foil around each pair
- Grounding: galvanized copper wire Ø0.4 mm

| TEMPERATURE CHARACTERISTICS |            |
|-----------------------------|------------|
| Storage Temperature [°C]    | -20 to +70 |
| Operating Temperature [°C]  | -20 to +70 |
| During installation [°C]    | -5° to +50 |

# S/FTP Cat.6<sub>A</sub> 500 MHz

## Rapid 6a

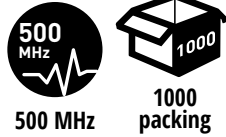

### Cable construction

1. Insulation
2. Drain wire
3. Conductor
4. Aluminium foil
5. Braid
6. Jacket

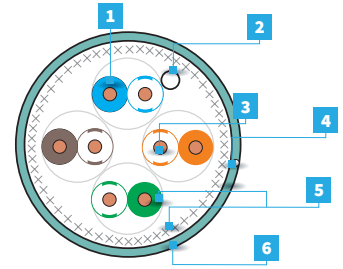

|             |                                  |
|-------------|----------------------------------|
| 1000 m drum | XR100F147                        |
|             | JACKET - FR-LSZH AQUA (RAL 6027) |

| MECHANICAL CHARACTERISTICS                   |  |
|--|--|
| Min. bending radius in operation [mm]        | 30   |
| Min. bending radius during installation [mm] | 60   |
| Max. pulling tension [N]                     | 110  |
| Nominal weight [kg/km]                       | 60   |
| Nom. outer diameter [mm]                     | 7.6  |
| Nom. wire diameter [AWG]                     | 23   |
| ELECTRICAL CHARACTERISTICS @ 20°C            |  |
| Max. DC Resistance [Ω/km]                    | 95   |
| Nom. Mutual Capacity @1kHz [nF/km]           | 45   |
| NVP [%]                                      | 80   |
| Mean input Impedance [Ω]                     | 100 ± 5 @ 100MHz                                     |
| Segregation class                            | d  |
| Coupling attenuation [dB]                    | Min.80   |
| ENVIRONMENTAL CHARACTERISTICS                |  |
| Jacket material                              | LSFRZH   |
| Flammability                                 | Acc. to IEC 60332-3-24, IEC 60754-1/2; IEC 61034-1/2 |
| Calorific value [MJ/m]                       | 0.62   |

| Frequency [MHz] | Max. attenuation [dB/100 m] | NEXT           |         |       |          | Return loss [dB] |
|-----------------|-----------------------------|----------------|---------|-------|----------|------------------|
|                 |                             | NEXT           | PS-NEXT | ACR-F | PS-ACR-F |                  |
|                 |                             | [dB/100 m] min |         |       |          |                  |
| 4               | 3.6                         | 100            | 100     | 91.2  | 88.2     | 28.0             |
| 16              | 7.2                         | 100            | 100     | 89.4  | 86.4     | 30.0             |
| 20              | 8.0                         | 100            | 100     | 89.0  | 86.0     | 30.0             |
| 31.25           | 10.0                        | 100            | 100     | 88.0  | 85.0     | 28.6             |
| 62.5            | 14.2                        | 100            | 97.5    | 85.9  | 82.9     | 26.5             |
| 100             | 18.1                        | 97.4           | 94.4    | 84.0  | 81.0     | 25.1             |
| 155             | 22.7                        | 94.5           | 91.5    | 81.7  | 78.7     | 23.8             |
| 200             | 25.8                        | 92.9           | 89.9    | 80.1  | 77.1     | 23.0             |
| 240             | 29                          | 91.7           | 88.7    | 78.5  | 75.8     | 22.4             |
| 250             | 31.9                        | 91.4           | 88.4    | 75.7  | 75.5     | 22.3             |
| 350             | 34.6                        | 89.2           | 86.2    | 75.7  | 72.7     | 22.3             |
| 500             | 41.8                        | 86.9           | 83.9    | 72.1  | 69.1     | 22.3             |

\*for information only

### Applications

- 10BASE-T (IEEE 802.3)
- 100BASE-T (IEEE 802.3)
- 1000BASE-T (Gigabit Ethernet)
- 10GBASE-T (10Gigabit Ethernet)
- Power Over Ethernet

### Standards

- LSZH: PN-EN 61034, PN-EN 50267-2-1
- PN-EN 60332-1, PN-EN 60332-3-24
- ANSI/TIA/EIA 568-C.2 (Cat.6A)
- ISO/IEC 11801:2011
- PN-EN 50173:2011

### Construction

- Conductor (wire) - 23 AWG (0.574 mm)
- Insulation: polyolefin
- Pair number: 4 twisted pairs
- Jacket: LSZH aqua in accordance with IEC 60322-1
- Jacket: FR-LSZH aqua
- Shield: aluminium/polyester foil around each pair
- Shield: Braid around all pairs
- Grounding: galvanized copper wire Ø0.4 mm

| TEMPERATURE CHARACTERISTICS [°C] |              |
|----------------------------------|--------------|
| Storage                          | -20° to +70° |
| Operating                        | -20° to +70° |
| During installation              | 0° to +50°   |

# S/FTP Cat.7 900 MHz

## ULTRA 7



### Cable construction

1. Insulation
2. Drain wire
3. Conductor
4. Aluminium foil
5. Braid
6. Jacket

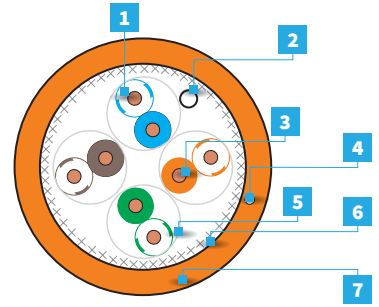

|             |                         |
|-------------|-------------------------|
| 1000 m drum | X9U100F147              |
|             | JACKET - FR-LSZH ORANGE |

| MECHANICAL CHARACTERISTICS                   |  |                |         |       |          |                  |
|--|--|----------------|---------|-------|----------|------------------|
| Min. bending radius in operation [mm]        | 30   |                |         |       |          |                  |
| Min. bending radius during installation [mm] | 60   |                |         |       |          |                  |
| Max. pulling tension [N]                     | 120  |                |         |       |          |                  |
| Nominal weight [kg/km]                       | 61   |                |         |       |          |                  |
| Nom. outer diameter [mm]                     | 7.6  |                |         |       |          |                  |
| Nom. wire diameter [AWG]                     | 23   |                |         |       |          |                  |
| ELECTRICAL CHARACTERISTICS @ 20°C            |  |                |         |       |          |                  |
| Max. DC Resistance [Ω/km]                    | 95   |                |         |       |          |                  |
| Nom. Mutual Capacity @1kHz [nF/km]           | 45   |                |         |       |          |                  |
| NVP [%]                                      | 80   |                |         |       |          |                  |
| Mean input Impedance [Ω]                     | 100 ± 5 @ 100MHz                                     |                |         |       |          |                  |
| Segregation class                            | d  |                |         |       |          |                  |
| Coupling attenuation [dB]                    | Min.80   |                |         |       |          |                  |
| ENVIRONMENTAL CHARACTERISTICS                |  |                |         |       |          |                  |
| Jacket material                              | FR-LSZH  |                |         |       |          |                  |
| Flammability                                 | Acc. to IEC 60332-3-24, IEC 60754-1/2; IEC 61034-1/2 |                |         |       |          |                  |
| Calorific value [MJ/m]                       | 0.62   |                |         |       |          |                  |
| Frequency [MHz]                              | Max. attenuation [dB/100 m]                          | NEXT           | PS-NEXT | ACR-F | PS-ACR-F | Return loss [dB] |
|  |  | [dB/100 m] min |         |       |          |                  |
| 4  | 3.6  | 100            | 100     | 100   | 98.2     | 33.0             |
| 100  | 18.1   | 97.4           | 94.4    | 94.0  | 91.0     | 30.1             |
| 155  | 22.7   | 94.5           | 91.5    | 91.7  | 88.7     | 28.8             |
| 200  | 25.8   | 92.9           | 89.9    | 90.1  | 87.1     | 28.0             |
| 240  | 28.4   | 91.7           | 88.7    | 88.5  | 85.8     | 27.4             |
| 250  | 29.0   | 91.4           | 88.4    | 85.7  | 85.5     | 27.3             |
| 350  | 34.6   | 89.2           | 86.2    | 85.7  | 82.7     | 26.3             |
| 500  | 41.8   | 86.9           | 83.9    | 82.1  | 79.1     | 25.3             |
| 550  | 43.9   | 86.3           | 83.3    | 81.0  | 78.0     | 25.3             |
| 580  | 45.2   | 85.9           | 82.9    | 80.4  | 77.4     | 25.3             |
| 590  | 45.6   | 85.8           | 82.8    | 80.2  | 77.2     | 25.3             |
| 600  | 46.0   | 85.7           | 82.7    | 80.0  | 77.0     | 25.3             |

\*for information only

### Applications

- 10BASE-T (IEEE 802.3)
- 100BASE-T (IEEE 802.3)
- 1000BASE-T (Gigabit Ethernet)
- 10GBASE-T (10Gigabit Ethernet)
- Power Over Ethernet

### Standards

- ISO/IEC 11801
- EN 50173
- IEC 61156-5
- EN 50288-3-1
- IEC 60332-3-24
- IEC 60754-1/2
- IEC 61034-1/2

### Construction

- Conductor (wire) - 23 AWG (0.574mm)
- Insulation: polyolefin
- Pair number: 4 twisted pairs
- Jacket: LSZH orange in accordance with IEC 60322-1
- Jacket: FR-LSZH orange
- Shield: aluminium/polyester foil around each pair
- Shield: Braid around all pairs
- Grounding: galvanized copper wire Φ 0.4 mm

| TEMPERATURE CHARACTERISTICS |            |
|-----------------------------|------------|
| Storage Temperature [°C]    | -20 to +70 |
| Operating Temperature [°C]  | -20 to +70 |
| During installation [°C]    | 0° to +50  |

# S/FTP Cat.7<sub>A</sub> 1200 MHz

## ULTRA 7A

### Copper cabling

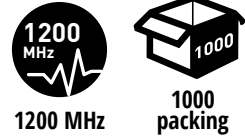

#### Cable construction

1. Insulation
2. Drain wire
3. Conductor
4. Aluminium foil
5. Braid
6. Jacket

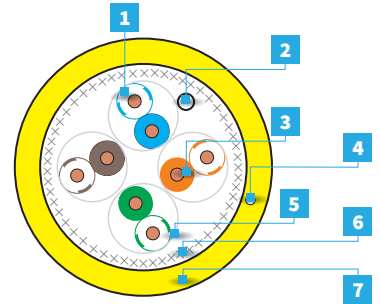

|             |                         |
|-------------|-------------------------|
| 1000 m drum | XUA100F146              |
|             | JACKET - FR-LSZH YELLOW |

| MECHANICAL CHARACTERISTICS                   |                  |
|--|------------------|
| Min. bending radius in operation [mm]        | 32               |
| Min. bending radius during installation [mm] | 64               |
| Max. pulling tension [N]                     | 142              |
| Nominal weight [kg/km]                       | 68               |
| Nom. outer diameter [mm]                     | 7.9              |
| Nom. wire diameter [AWG]                     | 23               |
| ELECTRICAL CHARACTERISTICS @ 20°C            |                  |
| Max. DC Resistance [Ω/km]                    | 95.0             |
| Nom. Mutual Capacity @1kHz [nF/km]           | 45               |
| NVP [%]                                      | 82               |
| Mean input Impedance [Ω]                     | 100 ± 5 @ 100MHz |
| Segregation class                            | d                |
| Coupling attenuation [dB]                    | min. 85          |

| ENVIRONMENTAL CHARACTERISTICS |  |
|-------------------------------|--|
| Jacket material               | LSFRZH   |
| Flammability                  | Acc. to IEC 60332-3-24, IEC 60754-1/2; IEC 61034-1/2 |
| Calorific value [MJ/m]        | 0.76   |

| Frequency [MHz] | Max. attenuation [dB/100 m] | NEXT           | PS-NEXT | ACR-F | PS-ACR-F | RL   |
|-----------------|-----------------------------|----------------|---------|-------|----------|------|
|                 |                             | [dB/100 m] min |         |       |          |      |
| 4               | 3.5                         | 105.0          | 105.0   | 90.0  | 87.2     | 28.0 |
| 100             | 16.9                        | 100.4          | 97.4    | 79.1  | 76.1     | 25.1 |
| 250             | 27.1                        | 94.4           | 91.4    | 66.4  | 67.7     | 22.3 |
| 500             | 39.0                        | 89.9           | 86.9    | 60.9  | 57.9     | 22.3 |
| 590             | 42.5                        | 88.8           | 85.8    | 58.0  | 55.3     | 22.3 |
| 600             | 42.9                        | 88.7           | 85.7    | 57.7  | 54.7     | 22.3 |
| 700             | 46.5                        | 87.4           | 84.4    | 54.7  | 51.7     | 21.6 |
| 800             | 49.9                        | 86.2           | 83.2    | 51.8  | 48.8     | 21.1 |
| 900             | 53.2                        | 85.2           | 82.2    | 49.1  | 46.1     | 20.5 |
| 1000            | 56.3                        | 84.3           | 81.3    | 46.6  | 43.6     | 20.1 |

- #### Applications
- 10BASE-T (IEEE 802.3)
  - 100BASE-T (IEEE 802.3)
  - 1000BASE-T (Gigabit Ethernet)
  - 10GBASE-T (10Gigabit Ethernet)
  - Power Over Ethernet

- #### Standards
- ISO/IEC 11801
  - EN 50173
  - IEC 61156-5
  - EN 50288-3-1
  - IEC 60332-3-24
  - IEC 60754-1/2
  - IEC 61034-1/2

- #### Construction
- Conductor (wire) - 23 AWG (0.574 mm)
  - Insulation: polyolefin
  - Pair number: 4 twisted pairs
  - Jacket: LSZH yellow in accordance with IEC 60322-1
  - Jacket: FR-LSZH yellow
  - Shield: aluminium/polyester foil around each pair
  - Shield: Braid around all pairs
  - Grounding: galvanized copper wire Φ 0.4 mm

# U/UTP Cat.3 25 pairs 25 MHz

**Voice**

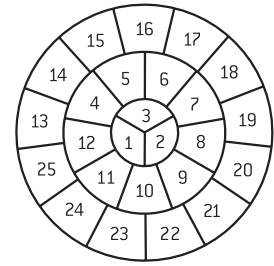
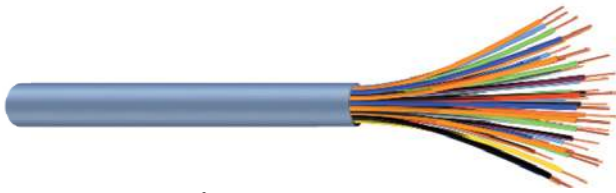

| 25 pairs Jacket PVC or LSZH U/UTP cable Cat.3 25 MHz |                   |                     |
|--|-------------------|---------------------|
| 1000 m drum  | XV125.103         | XV125.107           |
|  | JACKET - PVC GREY | JACKET - LSZH GREEN |

| ELECTRICAL AND CONSTRUCTION PARAMETERS                   |              |              |
|--|--------------|--------------|
| Resistance (max) ohm/100 m(328 ft) @ 20 °C               |              | 8.90         |
| Minimum dielectric strength between conductors (min) [V] |              | 1000         |
| Insulation strength (min) [MΩm*km]                       |              | 20000        |
| Impedence characteristic [Ohm]                           |              | (min-max)    |
| values at  | 772 kHz      | 87-117       |
|  | 1.0 - 16 MHz | 85-115       |
| Return loss (RL) dB (min)                                |              |              |
| values at  | 772 kHz      | 12           |
|  | 1.0 - 16 MHz | 12-log(f/10) |
| Construction   |              | 25x2x0.5     |
| Diameter [mm]  |              | 10.4         |
| Weight [kg/km]   |              | 162          |
| Drum size  |              | 08           |

| Frequency [MHz] | Max. attenuation [dB/100 m] | NEXT [dB/100 m] min |
|-----------------|-----------------------------|---------------------|
| 0.772           | 1.8                         | 72.0                |
| 1               | 2.1                         | 70.3                |
| 4               | 4.0                         | 61.3                |
| 10              | 6.2                         | 55.3                |
| 16              | 7.9                         | 52.2                |
| 25              | 10.0                        | 49.3                |

**Applications**

- PBX
- Point-to-Point
- Token Ring4 Mbit/s
- ATM LAN 51.84 Mbit/s
- ATM LAN 155.52 Mbit/s
- Analog and digital transmission of phone signals

**Standards**

- LSZH: PN-EN 61034, PN-EN 50267-2-1
- PN-EN 60332-1
- ANSI/TIA/EIA 568-C.2 (Cat.3)
- ISO/IEC 11801
- EN 50173, EN 50288

**Construction**

- Conductor (wire) - 24 AWG (0.51 mm)
- Insulation - polyolefin
- Pair number -25 twisted pairs
- Jacket - XV125.103 - PVC - grey
- Jacket - XV125.107 - LSZH - green

# U/UTP Cat.3 50 pairs 25 MHz

**Voice**

Copper cabling

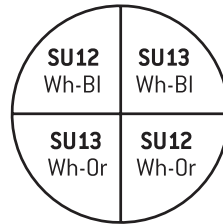
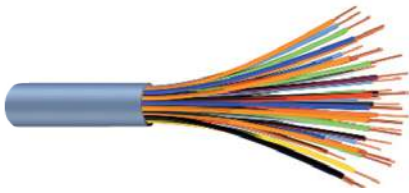

**Subunit kolor:**  
Wh-BI (White-Blue)  
Wh-Or (White-Orange)

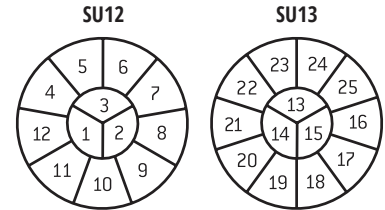

| 50 pairs Jacket PVC or LSZH U/UTP Cat.3 cable 25 MHz |                   |                     |
|--|-------------------|---------------------|
| 1000 m drum  | XV150.103         | XV150.107           |
|  | JACKET - PVC GREY | JACKET - LSZH GREEN |

| ELECTRICAL AND CONSTRUCTION PARAMETERS                   |              |              |
|--|--------------|--------------|
| Resistance (max) ohm/100 m(328 ft) @ 20 °C               |              | 8.90         |
| Minimum dielectric strength between conductors (min) [V] |              | 1000         |
| Insulation strength (min) [MΩm*km]                       |              | 20000        |
| Impedence characteristic [Ohm]                           |              | (min-max)    |
| values at  | 772 kHz      | 87-117       |
|  | 1.0 - 16 MHz | 85-115       |
| Return loss (RL) dB (min)                                |              |              |
| values at  | 772 kHz      | 12           |
|  | 1.0 - 16 MHz | 12-log(f/10) |
| Construction   |              | 50x2x0.5     |
| Diameter [mm]  |              | 13.8         |
| Weight [kg/km]   |              | 293          |
| Drum size  |              | 10           |

| Frequency [MHz] | Max. attenuation [dB/100 m] | NEXT [dB/100 m] min |
|-----------------|-----------------------------|---------------------|
| 0.772           | 1.8                         | 72.0                |
| 1               | 2.1                         | 70.3                |
| 4               | 4.0                         | 61.3                |
| 10              | 6.2                         | 55.3                |
| 16              | 7.9                         | 52.2                |
| 25              | 10.0                        | 49.3                |

**Applications**

- PBX
- Point-to-Point
- Token Ring 4 Mbit/s
- ATM LAN 51.84 Mbit/s
- ATM LAN 155.52 Mbit/s
- Analog and digital transmission of phone signals

**Standards**

- LSZH: PN-EN 61034, PN-EN 50267-2-1
- PN-EN 60332-1
- ANSI/TIA/EIA 568-C.2 (Cat.3)
- ISO/IEC 11801
- EN 50173, EN 50288

**Construction**

- Conductor (wire) - 24 AWG (0.51 mm)
- Insulation - polyolefin
- Pair number -50 twisted pairs
- Jacket - XV150.103 - PVC - grey
- Jacket - XV150.107 - LSZH - green



# U/UTP Cat.3 100 pairs 25 MHz

*Voice*

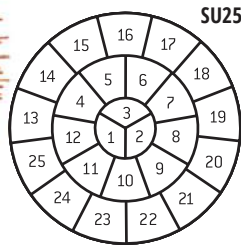

Subunit kolor:  
Wh-BI (White-Blue)  
Wh-Or (White-Orange)  
Wh-Gr (White-Green)  
WH-Br (White-Brown)

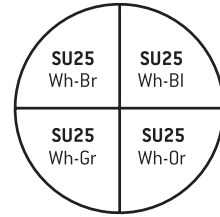

| 100 pairs Jacket PVC or LSZH U/UTP Cat.3 cable 25 MHz |                   |                     |
|---|-------------------|---------------------|
| 1000 m drum   | XV100.103         | XV100.107           |
|   | JACKET - PVC GREY | JACKET - LSZH GREEN |

| ELECTRICAL AND CONSTRUCTION PARAMETERS                   |              |              |
|--|--------------|--------------|
| Resistance (max) ohm/100 m(328 ft) @ 20 °C               |              | 89.5         |
| Minimum dielectric strength between conductors (min) [V] |              | 1000         |
| Insulation strength (min) [MΩm*km]                       |              | 20000        |
| Impedence characteristic [Ohm]                           |              | (min-max)    |
| values at  | 772 kHz      | 87-117       |
|  | 1.0 - 16 MHz | 85-115       |
| Return loss (RL) dB (min)                                |              |              |
| values at  | 1.0 - 10 MHz | 12           |
|  | 10 - 20 MHz  | 12-log(f/10) |
| Construction   |              | 100x2x0.5    |
| Diameter [mm]  |              | 19.1         |
| Weight [kg/km]   |              | 560          |
| Drum size  |              | 12           |

| Frequency [MHz] | Max. attenuation [dB/100 m] | NEXT [dB/100 m] min |
|-----------------|-----------------------------|---------------------|
| 0.772           | 1.8                         | 72.0                |
| 1               | 2.1                         | 70.3                |
| 4               | 4.0                         | 61.3                |
| 10              | 6.2                         | 55.3                |
| 16              | 7.9                         | 52.2                |
| 25              | 10.0                        | 49.3                |

**Applications**

- PBX
- Point-to-Point
- Token Ring4 Mbit/s
- ATM LAN 51.84 Mbit/s
- ATM LAN 155.52 Mbit/s
- Analog and digital transmission of phone signals

**Standards**

- LSZH: PN-EN 61034, PN-EN 50267-2-1
- PN-EN 60332-1
- ANSI/TIA/EIA 568-C.2 (Cat.3)
- ISO/IEC 11801
- EN 50173, EN 50288

**Construction**

- Conductor (wire) - 24 AWG (0.51 mm)
- Insulation - polyolefin
- Pair number -100 twisted pairs
- Jacket - XV100.103 - PVC - grey
- Jacket - XV100.107 - LSZH - green

# U/UTP Cat.5e 25 pairs

## 100 MHz Express 5e



### Copper cabling

#### Cable construction

1. Conductor
2. Insulation
3. Cable core
4. Braid
5. Jacket

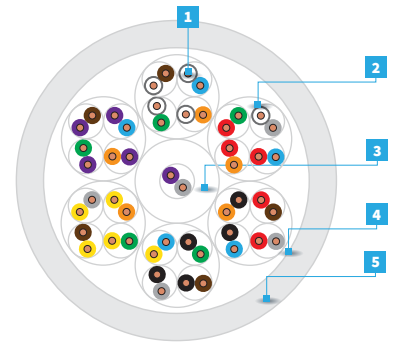

| FIBRAINDATA Express 25xU/UTP Cat.5e+ 100 MHz |                   |                     |
|--|-------------------|---------------------|
| 1000 m drum                                  | XE125.103         | XE125.107           |
|  | JACKET - PVC GREY | JACKET - LSZH GREEN |

| ELECTRICAL AND CONSTRUCTION PARAMETERS                 |               |                |
|--|---------------|----------------|
| Resistance (max) Ohm/100 m(328 ft) @ 20 °C             |               | 8.90           |
| Mutual capacitance (max) nF/100 m(328 ft) @ 1 kHz      |               | 5.20           |
| Nominal velocity of propagation NVP (% speed of light) |               | 68             |
| Impedence characteristic [Ohm]                         |               | (min-max)      |
| values at  | 772 kHz       | 87 - 117       |
|  | 1.0 - 200 MHz | 85 - 115       |
| Return loss (RL) dB (min)                              |               |                |
| values at  | 1.0 - 10 MHz  | 20+5 log(f)    |
|  | 10 - 20 MHz   | 25             |
|  | 20 - 100 MHz  | 25-7 log(f/20) |
| Propagation delay (max) [ns @ 10 MHz]                  |               | 518            |
| Delay skew (max) [ns/100 m]                            |               | 40             |
| Diameter [mm]  |               | 13.5           |
| Weight [kg/km]   |               | 205            |
| Minimal bending radius [mm]                            |               | 55             |
| Installation temperature [°C]                          |               | -20/+70        |
| Operating temperature [°C]                             |               | -20/+70        |

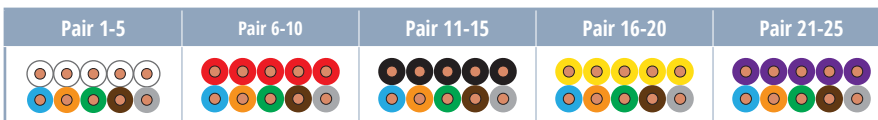

| Frequency [MHz] | Max. attenuation [dB/100 m] | NEXT           | PS-NEXT | ACR-F | PS-ACR-F | Return loss [dB] |
|-----------------|-----------------------------|----------------|---------|-------|----------|------------------|
|                 |                             | [dB/100 m] min |         |       |          |                  |
| 1               | 2.0                         | 65.3           | 62.3    | 61.0  | 58.0     | 20.0             |
| 4               | 4.1                         | 56.3           | 53.3    | 49.0  | 46.0     | 23.0             |
| 8               | 5.8                         | 51.3           | 48.3    | 42.0  | 39.9     | 24.5             |
| 10              | 6.5                         | 50.3           | 47.3    | 41.0  | 38.0     | 25.0             |
| 16              | 8.2                         | 47.3           | 44.3    | 36.9  | 33.9     | 25.0             |
| 20              | 9.3                         | 45.3           | 42.3    | 34.9  | 31.9     | 25.0             |
| 25              | 10.4                        | 44.3           | 41.3    | 33.0  | 30.0     | 24.3             |
| 31.25           | 11.7                        | 42.9           | 39.9    | 31.0  | 28.0     | 23.6             |
| 62.5            | 17.0                        | 38.4           | 35.4    | 25.1  | 22.1     | 21.5             |
| 100             | 22.0                        | 35.3           | 32.3    | 21.0  | 18.0     | 20.1             |

#### Applications

- 10BASE-T (IEEE 802.3)
- 4/16 Mbps Token Ring (IEEE 802.5)
- 100BASE-VG-AnyLAN
- 100Mbps TP-PMD (ANSI X3T9.5)
- 100BASE-T (IEEE 802.3)
- 55/155 Mbps ATM
- 1000BASE-T (Gigabit Ethernet)

#### Standards

- PN-EN 60332-1
- ANSI/TIA/EIA 568-C.2 (Cat.5e)
- ISO/IEC 11801:2011
- IEC 61156-5
- PN-EN 50173, PN-EN 50288

#### Construction

- Conductor (wire) - 24 AWG (0.51 mm)
- Insulation - polyolefin
- Pair number - 25 twisted pairs
- Jacket - grey PVC
- Jacket - green LSZH

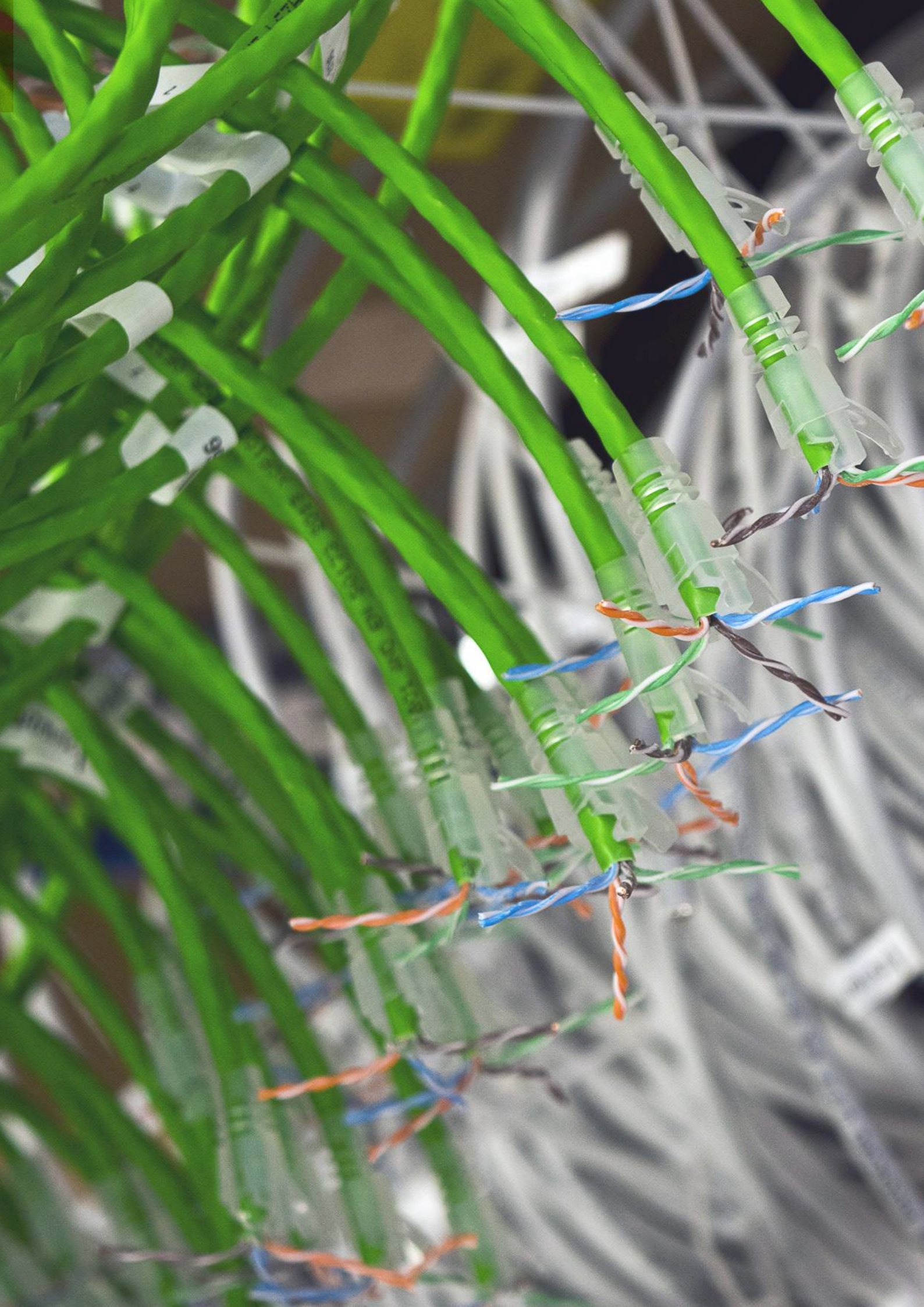

# COPPER



# FIBRAINDATA

## FIBRAINDATA CONNECTORS

Safety systems and the highest protection



### UNIVERSAL TOOL

Construction ensures termination of all conductors



### RE-EMBEDDED PASS

Modules from cat. 6 and higher are verified with the use of Re-Embedded method - confirmed with 3P Third Part Test certificate



### RJ45 CONNECTOR PROTECTION

Wire separator protecting the module against degradation



### SMALL DIMENSIONS

Modules with small dimensions guarantee high density of packaging

# CONNECTORS

against potential risks



**NON-SHIELDED  
MODULES**



**SHIELDED  
MODULES**



**FIELD  
TERMINABLE PLUG**



**PAIR SEPARATION**

Transmission pair separation system inside keystone module



**FARADAY CAGE**

One solid body ensures protection against outside disruptions



**SCREENED CAT. 6<sub>A</sub> PLUG**



**SUPPORT FOR UP TO  
10GBASE-T APPLICATION**



**PAIR SEPARATION ON IDC  
CONNECTIONS**

Angular IDC connections placed at different angle compared to nearby pairs



**IP20**

**IP20 PROTECTION LEVEL**



**ANGULAR IDC CONNECTION**

In each element we take care of dynamic parameters- angular connection reducing RL and NEXT



**FIBRAIN PACKING**

Modules are packed separately in Easy Open and clearly marked bags

# Keystone module Cat.5e UTP

Copper cabling

## Express 5e

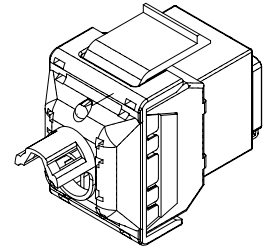
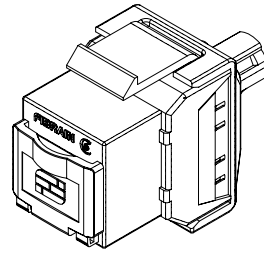

Keystone FIBRAINDATA Cat.5e UTP with green anti-dust cover

XE100.400

WITH GREEN ANTI-DUST COVER



Colorful cover



<1 min  
installation time

### ELECTRICAL AND MECHANICAL PARAMETERS

|                                 |  |
|---------------------------------|--|
| Compliance with the norm        | ISO 11801 ed.2.2. EN 50173. TIA 568-C.2. IEC 60603-7-3 |
| Operating temperature           | -10 °C to 60 °C  |
| Storage temperature             | -40 °C to 70 °C  |
| Connector class                 | Cat.5/Cat.6  |
| Shielding                       | none   |
| Housing material                | UL-94-V0   |
| Max. amperage [A]               | 1.5  |
| Min. insulation resistance [MΩ] | 500  |
| Max DC resistance [Ω]           | 0.1  |
| Contact material                | Phosphor-bronze (CuSN)                                 |
| Contacts                        | Min 0.75 µm gold layer, min. 1.3 µm nickel layer       |
| IDC connector material          | Phosphor-bronze (CuSN)                                 |
| IDC covering                    | Min 1.27 µm silver layer, min. 2.5 µm nickel layer     |
| Conductor diameter range (wire) | 0.4 mm (AWG26) – 0.65 mm (AWG22)                       |
| Conductor diameter range (rope) | AWG26/7 – AWG22/7                                      |
| Min. connection cycles qty      | 750  |
| Min. module re-termination      | 20   |
| Mounting                        | keystone   |

### Features

- Tool-less
- Housing minimizes wires unbraiding
- Flame-retardant materials UL94V-0
- Anti-dust cover
- Sequence identification 568A and 568B

### Standards

- "Keystone" standard ensures assembly compatibility
- Structured cabling standards ISO/IEC 11801:2011, EN 0173:2011, TIA/EIA568 - C.2
- Verification in accordance with the new standards by independent laboratory centres

### Accessories

- **XB-DC-W-01** 25 pcs white anti-dust covers
- **XB-DC-Y-01** 25 pcs yellow anti-dust covers
- **XB-DC-R-01** 25 pcs red anti-dust covers
- **XB-DC-BK-01** 25 pcs black anti-dust covers
- **XT100.KEY** Automatic clamping tool



# Keystone module Cat.5e FTP/STP

Express 5e

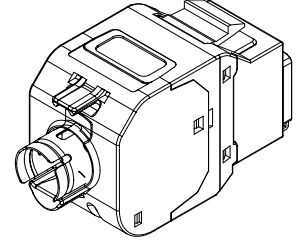
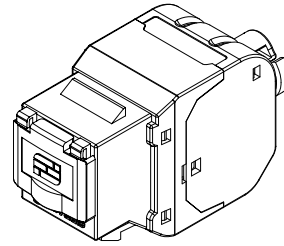

Keystone FIBRAINDATA Cat.5e FTP/STP with green anti-dust cover

XE100.450

WITH GREEN ANTI-DUST COVER



Colorful cover



<1 min installation time

| ELECTRICAL AND MECHANICAL PARAMETERS |  |
|--------------------------------------|--|
| Compliance with the norm             | ISO 11801 ed.2.2. EN 50173. TIA 568-C.2. IEC 60603-7-3 |
| Operating temperature                | -10 °C to 60 °C  |
| Storage temperature                  | -40 °C to 70 °C  |
| Connector class                      | Cat.5/Cat.6  |
| Shielding                            | yes  |
| Housing material                     | UL-94-V0   |
| Max. amperage [A]                    | 1.5  |
| Min. insulation resistance [MΩ]      | 500  |
| Max DC resistance [Ω]                | 0.1  |
| Contact material                     | Phosphor-bronze (CuSN)                                 |
| Contacts                             | Min 0.75 µm gold layer, min. 1.3 µm nickel layer       |
| IDC connector material               | Phosphor-bronze (CuSN)                                 |
| IDC covering                         | Min 1.27 µm silver layer, min. 2.5 µm nickel layer     |
| Conductor diameter range (wire)      | 0.4 mm (AWG26) – 0.65 mm (AWG22)                       |
| Conductor diameter range (rope)      | AWG26/7 – AWG22/7                                      |
| Min. connection cycles qty           | 750  |
| Min. module re-termination           | 20   |
| Mounting                             | keystone   |

- Features**
- Tool-less
  - Housing minimizes wires unbraiding
  - Flame-retardant materials UL94V-0
  - Anti-dust cover
  - Sequence identification 568A and 568B

- Standards**
- "Keystone" standard ensures assembly compatibility
  - Structured cabling standards ISO/IEC 11801:2011, EN 0173:2011, TIA/EIA568 - C.2
  - Verification in accordance with the new standards by independent laboratory centres

- Accessories**
- **XB-DC-W-01** 25 pcs white anti-dust covers
  - **XB-DC-Y-01** 25 pcs yellow anti-dust covers
  - **XB-DC-R-01** 25 pcs red anti-dust covers
  - **XB-DC-BK-01** 25 pcs black anti-dust covers
  - **XT100.KEY** Automatic clamping tool



# Keystone module Cat.6 UTP

Copper cabling

## Quick 6

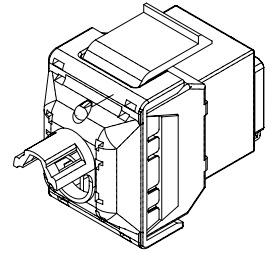
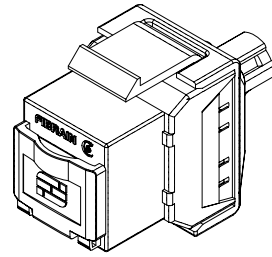

Keystone FIBRAINDATA Cat.6 UTP with blue anti-dust cover

XQ100.400

WITH BLUE ANTI-DUST COVER



Third Party Testing



Colorful cover



<1 min installation time

### ELECTRICAL AND MECHANICAL PARAMETERS

|                                 |  |
|---------------------------------|--|
| Compliance with the norm        | ISO 11801 ed.2.2. EN 50173. TIA 568-C.2. IEC 60603-7-3 |
| Operating temperature           | -10 °C to 60 °C  |
| Storage temperature             | -40 °C to 70 °C  |
| Connector class                 | Cat.5/Cat.6  |
| Shielding                       | none   |
| Housing material                | UL-94-V0   |
| Max. amperage [A]               | 1.5  |
| Min. insulation resistance [MΩ] | 500  |
| Max DC resistance [Ω]           | 0.1  |
| Contact material                | Phosphor-bronze (CuSN)                                 |
| Contacts                        | Min 0.75 μm gold layer, min. 1.3 μm nickel layer       |
| IDC connector material          | Phosphor-bronze (CuSN)                                 |
| IDC covering                    | Min 1.27 μm silver layer, min. 2.5 μm nickel layer     |
| Conductor diameter range (wire) | 0.4 mm (AWG26) – 0.65 mm (AWG22)                       |
| Conductor diameter range (rope) | AWG26/7 – AWG22/7                                      |
| Min. connection cycles qty      | 750  |
| Min. module re-termination      | 20   |
| Mounting                        | keystone   |

#### Features

- Tool-less
- Housing minimizes wires unbraiding
- Flame-retardant materials UL94V-0
- Anti-dust cover
- Sequence identification 568A and 568B

#### Standards

- "Keystone" standard ensures assembly compatibility
- Structured cabling standards ISO/IEC 11801:2011, EN 0173:2011, TIA/EIA568 - C.2
- Verification in accordance with the new standards by independent laboratory centres

#### Accessories

- **XB-DC-W-01** 25 pcs white anti-dust covers
- **XB-DC-Y-01** 25 pcs yellow anti-dust covers
- **XB-DC-R-01** 25 pcs red anti-dust covers
- **XB-DC-BK-01** 25 pcs black anti-dust covers
- **XT100.KEY** Automatic clamping tool





**Quick 6**

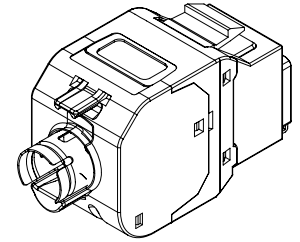
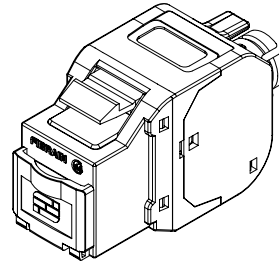

|  |
|--|
| Keystone FIBRAINDATA Cat.6 FTP/STP with blue anti-dust cover |
| XQ100.450  |
| WITH BLUE ANTI-DUST COVER                                    |



Third Party Testing



Colorful cover



<1 min installation time

| ELECTRICAL AND MECHANICAL PARAMETERS |  |
|--------------------------------------|--|
| Compliance with the norm             | ISO 11801 ed.2.2. EN 50173. TIA 568-C.2. IEC 60603-7-3 |
| Operating temperature                | -10 °C to 60 °C  |
| Storage temperature                  | -40 °C to 70 °C  |
| Connector class                      | Cat.5/Cat.6  |
| Shielding                            | yes  |
| Housing material                     | UL-94-V0   |
| Max. amperage [A]                    | 1.5  |
| Min. insulation resistance [MΩ]      | 500  |
| Max DC resistance [Ω]                | 0.1  |
| Contact material                     | Phosphor-bronze (CuSn)                                 |
| Contacts                             | Min 0.75 µm gold layer, min. 1.3 µm nickel layer       |
| IDC connector material               | Phosphor-bronze (CuSn)                                 |
| IDC covering                         | Min 1.27 µm silver layer, min. 2.5 µm nickel layer     |
| Conductor diameter range (wire)      | 0.4 mm (AWG26) – 0.65 mm (AWG22)                       |
| Conductor diameter range (rope)      | AWG26/7 – AWG22/7                                      |
| Min. connection cycles qty           | 750  |
| Min. module re-termination           | 20   |
| Mounting                             | keystone   |

**Features**

- Tool-less
- Housing minimizes wires unbraiding
- Flame-retardant materials UL94V-0
- Anti-dust cover
- Sequence identification 568A and 568B

**Standards**

- "Keystone" standard ensures assembly compatibility
- Structured cabling standards ISO/IEC 11801:2011, EN 0173:2011, TIA/EIA568 - C.2
- Verification in accordance with the new standards by independent laboratory centres

**Accessories**

- **XB-DC-W-01** 25 pcs white anti-dust covers
- **XB-DC-Y-01** 25 pcs yellow anti-dust covers
- **XB-DC-R-01** 25 pcs red anti-dust covers
- **XB-DC-BK-01** 25 pcs black anti-dust covers
- **XT100.KEY** Automatic clamping tool



# Keystone module Cat.6<sub>A</sub> FTP/STP

Copper cabling

## Rapid 6a

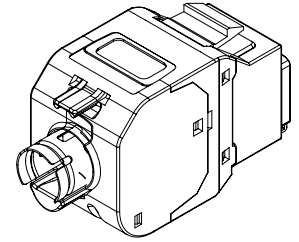
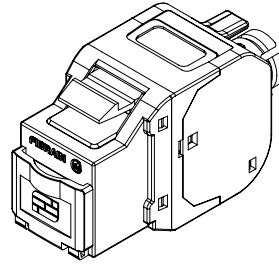

Keystone FIBRAINDATA Cat.6<sub>A</sub> FTP/STP with aqua anti-dust cover

XR100.450

WITH AQUA ANTI-DUST COVER



Third Party Testing



Colorful cover



<1 min installation time

### ELECTRICAL AND MECHANICAL PARAMETERS

|                                 |  |
|---------------------------------|--|
| Compliance with the norm        | ISO 11801 ed.2.2. EN 50173. TIA 568-C.2. IEC 60603-7-3 |
| Operating temperature           | -10 °C to 60 °C  |
| Storage temperature             | -40 °C to 70 °C  |
| Connector class                 | Cat.5/Cat.6/Cat.6 <sub>A</sub>                         |
| Shielding                       | yes  |
| Housing material                | UL-94-V0   |
| Max. amperage [A]               | 1.5  |
| Min. insulation resistance [MΩ] | 500  |
| Max DC resistance [Ω]           | 0.1  |
| Contact material                | Phosphor-bronze (CuSN)                                 |
| Contacts                        | Min 0.75 μm gold layer, min. 1.3 μm nickel layer       |
| IDC connector material          | Phosphor-bronze (CuSN)                                 |
| IDC covering                    | Min 1.27 μm silver layer, min. 2.5 μm nickel layer     |
| Conductor diameter range (wire) | 0.4 mm (AWG26) – 0.65 mm (AWG22)                       |
| Conductor diameter range (rope) | AWG26/7 – AWG22/7                                      |
| Min. connection cycles qty      | 750  |
| Min. module re-termination      | 20   |
| Mounting                        | keystone   |

#### Features

- Tool-less
- Housing minimizes wires unbraiding
- Flame-retardant materials UL94V-0
- Anti-dust cover
- Sequence identification 568A and 568B

#### Standards

- "Keystone" standard ensures assembly compatibility
- Structured cabling standards ISO/IEC 11801:2011, EN 0173:2011, TIA/EIA568 - C.2
- Verification in accordance with the new standards by independent laboratory centres

#### Accessories

- **XB-DC-W-01** 25 pcs white anti-dust covers
- **XB-DC-Y-01** 25 pcs yellow anti-dust covers
- **XB-DC-R-01** 25 pcs red anti-dust covers
- **XB-DC-BK-01** 25 pcs black anti-dust covers
- **XT100.KEY** Automatic clamping tool



# Field Plug Cat.6<sub>A</sub> FTP/STP

**Rapid 6a**

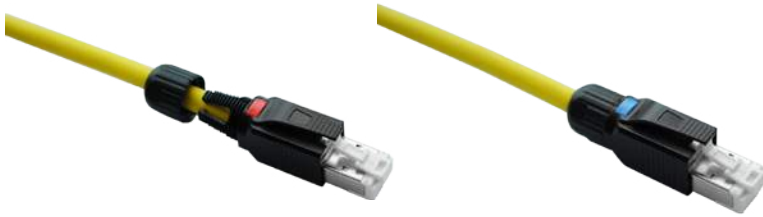

## Connection modules/plugs



IP20 resistance



Two types of wire manager



10Gbps bandwidth

- Features**
- Industry compatible design
  - 360° shielding for better EMI/EMC
  - Integrated strain relief
  - Field and easy install
  - Compatible with EN 50173 / ISO IEC 118

|   |
|---|
| Field Plug FIBRAINDATA Cat.6 <sub>A</sub> FTP/STP |
| XR100.350   |
| FOR 22-23 AND 24-26 AWG                           |

| ELECTRICAL AND MECHANICAL PARAMETERS |                         |
|--------------------------------------|-------------------------|
| Maximum current value [A]            | 1.5                     |
| Insulation strength [MΩ] min         | 500                     |
| Contacts resistance [MΩ] max         | 20                      |
| DC Resistance [Ω] max                | 0.1                     |
| Compliance with the norm             | IEC 11801 2nd Ed. Am. 1 |
| Compliance with the norm             | ANSI/TIA/EIA 568-C-2.1  |
| Jacket                               | Shielded RJ45 Cat.6A    |
| Housing                              | UL94V-0                 |
| Sequence identification              | T568A and T568B         |

- Norms**
- Qualified Screened Class EA/Cat.6A
  - Permanent Link & Channel ANSI/TIA-568-C.2
  - IEC 60603-7-51
  - ISO/IEC 11801 2.2 Edition
  - CENELEC EN 50173-1:201



## Field plug Cat.6<sub>A</sub> FTP/STP

Manufacturing technology

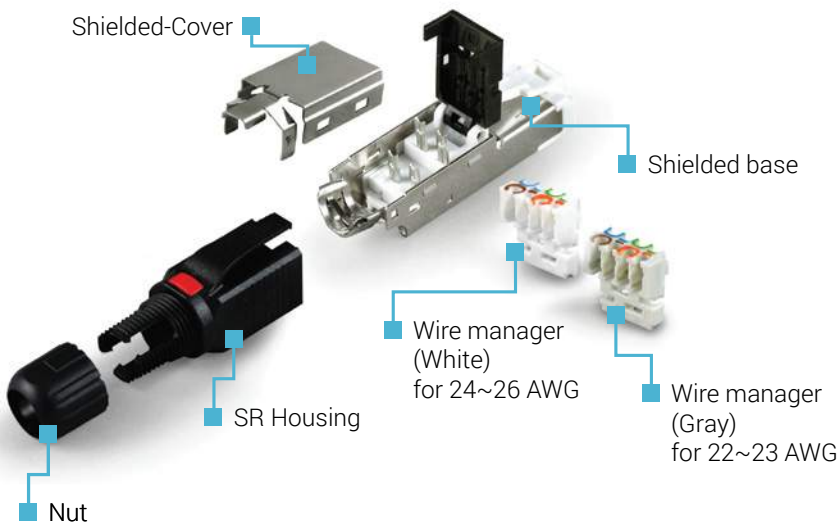

# COPPER



# FIBRAINDATA

## PATCH PANELS

Trust first-class components, trust Fibrain quality



### CABLE SHELF ARRANGEMENT

To facilitate arrangement panels are always equipped with cable shelf



### PORTS PACKAGING

Panels are available in 1U and 0.5 U option ensuring termination up to 24 ports



### WELL - EQUIPPED

A set of cable ties, M6 screws, installation guide together with a panel



### RE-EMBEDDED PASS

Panels from cat. 6 and higher are verified with the use of Re-Embedded method confirmed with 3P Third Party Test Certificate

# PATCH PANELS

**UTP**

UNSHIELDED PANELS



**ANGULAR IDC CONNECTION**

In each element we take care of dynamic parameters-angular connection reduces RL and NEXT

**FTP**

SHIELDED PANELS



**FARADAY CAGE**

In a complete panel there is a shielded cover with a shielded grounding point



**9-PIN IDC CONNECTOR**

Panels have 3 independent contact points with shield due to extra pin on IDC connection

**FO/CU**

FULLY SCALABLE AND MODULAR SOLUTION FO/CU



**PANEL WITH NOBLE METALS**

IDC Couplers covered with 1.27  $\mu\text{m}$  silver layer  
Contacts covered with 50  $\mu\text{m}$  gold layer

Express 5e

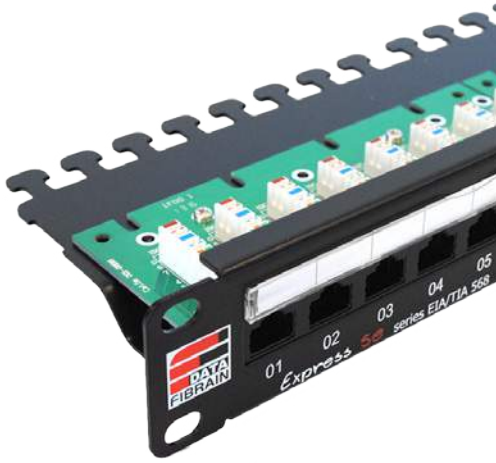

Patch panel 1U Express 5e XE100.200  
UTP 24 ports

- Standards**
- 19" standard - facilitates mounting
  - Structured cabling comply with ISO/IEC 11801:2011, EN 50173:2011, TIA/EIA 568-C.2 standards
  - Verification in accordance with the new standards by independent laboratory centres

- Features**
- 1U, 19"
  - Depth: 110 mm
  - 8-pin IDC connectors
  - Material: powder-coated sheet, black
  - Facilitated cable arrangement (cable shelf)
  - Exchangeable description field
  - Clear numbering of ports and panels

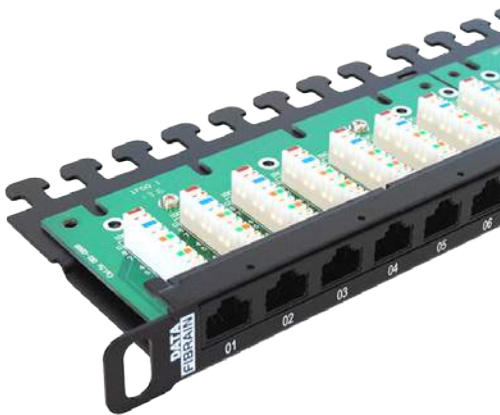

Patch panel 0.5U Express 5e XE100.205  
UTP 24 ports

- Standards**
- 19" standard - facilitates mounting
  - Structured cabling comply with ISO/IEC 11801:2011, EN 50173:2011, TIA/EIA 568-C.2 standards
  - Verification in accordance with the new standards by independent laboratory centres

- Features**
- 0.5U, 19"
  - Depth: 95 mm
  - 8-pin IDC connectors
  - Material: powder-coated sheet, black
  - Facilitated cable arrangement (cable shelf)
  - Clear numbering of ports and panels

ELECTRICAL AND MECHANICAL PARAMETERS

|                                |   |
|--------------------------------|---|
| Maximum current value [A]      | 1.5   |
| Insulation strength [MOhm] min | 500   |
| Contacts resistance [MOhm] max | 20  |
| DC Resistance [Ohm] max        | 0.1   |
| Compliance with the norm       | IEC 60603-7 Class D   |
| Compliance with the norm       | TIA568-B Cat.5e   |
| Frame                          | 1.5 mm steel sheet  |
| Jacket                         | Non-shielded RJ45 Cat.5e  |
| Housing                        | UL94V-0 black thermoplastic                                       |
| Contact material               | phosphor-bronze   |
| Contacts                       | 0.46mm diameter covered with 0.75 µm gold and 1.3 µm nickel layer |
| Jack durability                | >750 connection cycles in accordance with EN60603-7               |
| IDC connector                  | IDC LSA   |
| Wire diameter                  | 0.4-0.65 mm (AWG26-22)  |
| IDC durability                 | >200 connection cycles  |
| Coupler material               | phosphor-bronze   |
| Coupler coating                | 1.27 µm silver and 2.5 µm nickel layer                            |
| Sequence identification        | T568A and T568B   |

Express 5e



Patch panel 1U Express 5e XE100.250

FTP/STP 24 ports



Standards

- 19" standard - facilitates mounting
- Structured cabling comply with ISO/IEC 11801:2011, EN 50173:2011, TIA/EIA 568-C.2 standards
- Verification in accordance with the new standards by independent laboratory centres



Features

- 1U, 19"
- Depth: 110 mm
- 9-pin IDC connectors
- Shielded cover connected to grounding point
- Material: powder-coated sheet, black
- Facilitated cable arrangement (cable shelf)
- Exchangeable description field
- Clear numbering of ports and panels



Patch panel 0.5U Express 5e XE100.255

FTP/STP 24 ports



Standards

- 19" standard - facilitates mounting
- Structured cabling comply with ISO/IEC 11801:2011, EN 50173:2011, TIA/EIA 568-C.2 standards
- Verification in accordance with the new standards by independent laboratory centres



Features

- 0.5U, 19"
- Depth: 95 mm
- 9-pin IDC connectors
- Shielded cover connected to grounding point
- Facilitated cable arrangement (cable shelf)
- Clear numbering of ports and panels

ELECTRICAL AND MECHANICAL PARAMETERS

|                                |   |
|--------------------------------|---|
| Maximum current value [A]      | 1.5   |
| Insulation strength [MOhm] min | 500   |
| Contacts resistance [MOhm] max | 20  |
| DC Resistance [Ohm] max        | 0.1   |
| Compliance with the norm       | IEC 60603-7 Class D   |
| Compliance with the norm       | TIA568-B Cat.5e   |
| Frame                          | 1.5 mm steel sheet  |
| Shield                         | Shielded cover made of 1.0 mm galvanized steel                    |
| Jacket                         | Shielded RJ45 Cat.5e  |
| Housing                        | UL94V-0 black thermoplastic                                       |
| Contact material               | phosphor-bronze   |
| Contacts                       | 0.48mm diameter covered with 0.75 µm gold and 1.3 µm nickel layer |
| Jack durability                | >750 connection cycles in accordance with EN60603-7               |
| IDC connector                  | IDC LSA   |
| Wire diameter                  | 0.4-0.65 mm (AWG26-22)  |
| IDC durability                 | >200 connection cycles  |
| Coupler material               | phosphor-bronze   |
| Coupler coating                | 1.27 µm silver and 2.5 µm nickel layer                            |
| Sequence identification        | T568A and T568B   |

**Quick 6**

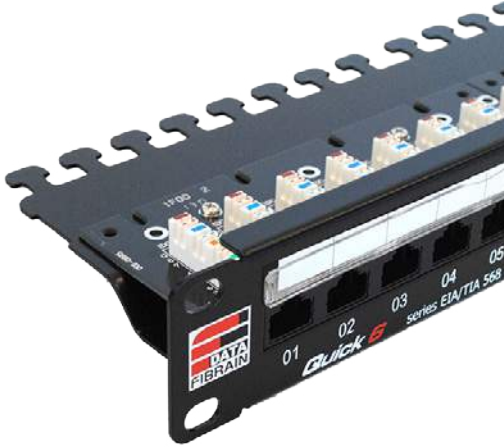

**Patch panel 1U Quick 6 XQ100.200**  
UTP 24 ports

- Standards**
- 19" standard - facilitates mounting
  - Structured cabling comply with ISO/IEC 11801:2011, EN 50173:2011, TIA/EIA 568-C.2 certified by independent laboratory centres
  - Verification in accordance with the new standards by independent laboratory centres

- Features**
- 1U, 19"
  - Depth: 110 mm
  - 8-pin IDC connectors
  - Material: powder-coated sheet, black RAL9005
  - Facilitated cable arrangement (cable shelf)
  - Exchangeable description field
  - Clear numbering of ports and panels

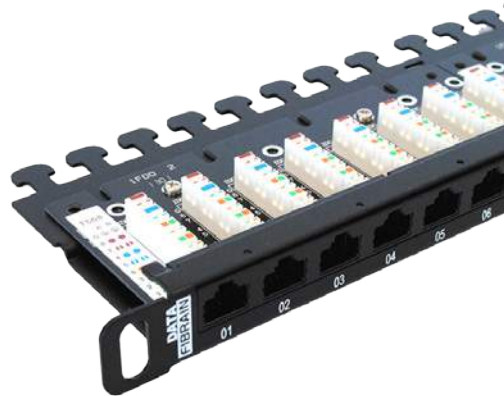

**Patch panel 0.5U Quick 6 XQ100.205**  
UTP 24 ports

- Standards**
- 19" standard - facilitates mounting
  - Structured cabling comply with ISO/IEC 11801:2011, EN 50173:2011, TIA/EIA 568-C.2 certified by independent laboratory centres
  - Verification in accordance with the new standards by independent laboratory centres

- Features**
- 0.5U, 19"
  - Depth: 95 mm
  - 8-pin IDC connectors
  - Material: powder-coated sheet, black RAL9005
  - Facilitated cable arrangement (cable shelf)
  - Clear numbering of ports and panels

**ELECTRICAL AND MECHANICAL PARAMETERS**

|                              |   |
|------------------------------|---|
| Insulation strength [MΩ] min | 500   |
| Contacts resistance [MΩ] max | 20  |
| DC Resistance [Ω] max        | 0.1   |
| Compliance with the norm     | IEC 60603-7 Class E   |
| Compliance with the norm     | TIA568-B Cat.6  |
| Frame                        | 1.5 mm steel sheet  |
| Jacket                       | Non-shielded RJ45 Cat.6   |
| Housing                      | UL94V-0 black thermoplastic                                       |
| Contact material             | phosphor-bronze   |
| Contacts                     | 0.46mm diameter covered with 0.75 μm gold and 1.3 μm nickel layer |
| Jack durability              | >750 connection cycles in accordance with EN60603-7               |
| IDC connector                | IDC LSA   |
| Wire diameter                | 0.4-0.65 mm (AWG26-22)  |
| IDC durability               | >200 connection cycles  |
| Coupler material             | phosphor-bronze   |
| Coupler coating              | 1.27 μm silver and 2.5 μm nickel layer                            |
| Sequence identification      | T568A and T568B   |



**Quick 6**



**Patch panel 1U Quick 6 XQ100.250**  
FTP/STP 24 ports

- Standards**
- 19" standard - facilitates mounting
  - Structured cabling comply with ISO/IEC 11801:2011, EN 50173:2011, TIA/EIA 568-C.2 certified by independent laboratory centres
  - Verification in accordance with the new standards by independent laboratory centres

- Features**
- 1U, 19"
  - Depth: 110 mm
  - 9-pin IDC connectors
  - Shielded cover connected to grounding point
  - Material: powder-coated sheet, black
  - Facilitated cable arrangement (cable shelf)
  - Exchangeable description field
  - Clear numbering of ports and panels



**Patch panel 0.5U Quick 6 XQ100.255**  
FTP/STP 24 ports

- Standards**
- 19" standard - facilitates mounting
  - Structured cabling comply with ISO/IEC 11801:2011, EN 50173:2011, TIA/EIA 568-C.2 certified by independent laboratory centres
  - Verification in accordance with the new standards by independent laboratory centres

- Features**
- 0.5U, 19"
  - Depth: 95 mm
  - 9-pin IDC connectors
  - Shielded cover connected to grounding point
  - Facilitated cable arrangement (cable shelf)
  - Clear numbering of ports and panels

**ELECTRICAL AND MECHANICAL PARAMETERS**

|                                |   |
|--------------------------------|---|
| Maximum current value [A]      | 1.5   |
| Insulation strength [MOhm] min | 500   |
| Contacts resistance [MOhm] max | 20  |
| DC Resistance [Ohm] max        | 0.1   |
| Compliance with the norm       | IEC 60603-7 Class E   |
| Compliance with the norm       | TIA568-B Cat.6  |
| Frame                          | 1.5 mm steel sheet  |
| Shield                         | Shielded cover made of 1.0 mm galvanized steel                    |
| Jacket                         | Shielded RJ45 Cat.6   |
| Housing                        | UL94V-0 black thermoplastic                                       |
| Contact material               | phosphor-bronze   |
| Contacts                       | 0.48mm diameter covered with 0.75 µm gold and 1.3 µm nickel layer |
| Jack durability                | >750 connection cycles in accordance with EN60603-7               |
| IDC connector                  | IDC LSA   |
| Wire diameter                  | 0.4-0.65 mm (AWG26-22)  |
| IDC durability                 | >200 connection cycles  |
| Coupler material               | phosphor-bronze   |
| Coupler coating                | 1.27 µm silver and 2.5 µm nickel layer                            |
| Sequence identification        | T568A and T568B   |



**Patch panel 1U Rapid 6<sub>A</sub> XR100.250**

FTP/STP 24 ports



**Standards**

- 19" standard - facilitates mounting
- Structured cabling comply with ISO/IEC 11801:2011, EN 50173:2011, TIA/EIA 568-C.2 certified by independent laboratory centres
- Verification in accordance with the new standards by independent laboratory centres



**Features**

- 1U, 19"
- Depth: 110 mm
- 9-pin IDC connectors
- Material: powder-coated sheet, black
- Facilitated cable arrangement (cable shelf)
- Exchangeable description field
- Clear numbering of ports and panels



**Patch panel 0.5U Rapid 6<sub>A</sub> XR100.255**

FTP/STP 24 ports



**Standards**

- 19" standard - facilitates mounting
- Structured cabling comply with ISO/IEC 11801:2011, EN 50173:2011, TIA/EIA 568-C.2 certified by independent laboratory centres
- Verification in accordance with the new standards by independent laboratory centres



**Features**

- 0.5U, 19"
- Depth: 95 mm
- 9-pin IDC connectors
- Shielded cover connected to grounding point
- Facilitated cable arrangement (cable shelf)
- Clear numbering of ports and panels

**ELECTRICAL AND MECHANICAL PARAMETERS**

|                                |   |
|--------------------------------|---|
| Maximum current value [A]      | 1.5   |
| Insulation strength [MOhm] min | 500   |
| Contacts resistance [MOhm] max | 20  |
| DC Resistance [Ohm] max        | 0.1   |
| Compliance with the norm       | IEC 60603-7 Class EA  |
| Compliance with the norm       | TIA568-B Cat.6A   |
| Frame                          | 1.5 mm steel sheet  |
| Shield                         | Shielded cover made of 1.0 mm galvanized steel                    |
| Jacket                         | Shielded RJ45 Cat.6A  |
| Housing                        | UL94V-0 black thermoplastic                                       |
| Contact material               | phosphor-bronze   |
| Contacts                       | 0.48mm diameter covered with 0.75 µm gold and 1.3 µm nickel layer |
| Jack durability                | >750 connection cycles in accordance with EN60603-7               |
| IDC connector                  | IDC LSA   |
| Wire diameter                  | 0.4-0.65 mm (AWG26-22)  |
| IDC durability                 | >200 connection cycles  |
| Coupler material               | phosphor-bronze   |
| Coupler coating                | 1.27 µm silver and 2.5 µm nickel layer                            |
| Sequence identification        | T568A and T568B   |

# Patch Panel 1U24xRJ45u/s, empty



## TECHNICAL SPECIFICATIONS

|                          |                              |
|--------------------------|------------------------------|
| <b>Case material</b>     | Galvanised steel             |
| <b>Colour</b>            | Grey RAL 7035 (XB101.224)    |
|                          | Black RAL 9005 (XB101.224.1) |
| <b>Temperature range</b> | -40°C to +70°C               |
| <b>Height</b>            | 1U                           |
| <b>Width</b>             | 19" (                        |
| <b>Scope of supply</b>   | Frame, empty                 |
| <b>Weight [kg]</b>       | 2.1                          |

## Ordering information

| Code               | Description   |
|--------------------|---|
| <b>XB101.224</b>   | Patch Panel 1U24xRJ45u/s, empty, 1U, grey RAL 7035  |
| <b>XB101.224.1</b> | Patch Panel 1U24xRJ45u/s, empty, 1U, black RAL 9005 |

## Patch panels

### Description

- SD patch panel is the most flexible platform for serve either copper or FO connection. It can be equipped up to 24 RJ45 ports of Cat5-Cat6A or up to 96 fibers terminated with wide range of connectors LC/E2000/SC. Patch panel has 8 empty slots which can be equipped with copper holder (6x RJ45) or fully equipped FO cassettes spliced or for pre-terminated connectors including MPO/MTP connectors.

### Applications

- Nodal points of fiber optic networks
- Distribution points of fiber optic networks
- Server rooms

### Features

- 1U, 19"
- For all keystone modules (shielded/unshielded)
- Facilitated cable arrangement (cable shelf)
- Up to 24xRJ45/u/s
- Staggered port arrangement to avoid Alien-Crosstalk
- Exchangeable description field
- Coloured anti-dust covers
- Solid metal body for galvanised connection with modules shield (in case of using shielded modules)

# SD modular patch panel, empty



## TECHNICAL SPECIFICATIONS

|                            |                            |
|----------------------------|----------------------------|
| <b>Case material</b>       | Powder paint coated steel  |
| <b>Colour</b>              | Front: chrome-plated steel |
|                            | Closure: Black RAL 9005    |
| <b>Temperature range</b>   | -40°C to +70°C             |
| <b>Max. copper holders</b> | 4                          |
| <b>Max. FO cassettes</b>   | 8                          |
| <b>Scope of supply</b>     | Frame, empty               |
| <b>Weight [kg]</b>         | 2.1                        |

## Ordering information

| Code             | Description                   |
|------------------|-------------------------------|
| <b>XB100.2SD</b> | SD modular patch panel, empty |

### Description

- SD patch panel is the most flexible platform for serve either copper or FO connection. It can be equipped up to 24 RJ45 ports of Cat5-Cat6A or up to 96 fibers terminated with wide range of connectors LC/E2000/SC. Patch panel has 8 empty slots which can be equipped with copper holder (6x RJ45) or fully equipped FO cassettes spliced or for pre-terminated connectors including MPO/MTP connectors.

### Applications

- Nodal points of fiber optic networks
- Distribution points of fiber optic networks
- Server rooms

### Features

- Modular configuration system:
  - Possibility for FO/Cu assembling,
  - Different cable entry adapters for different cables fixed in the rear
  - Patch cables manager from front (optional)
- Capacity: up to 8 FO/Cu modules
- Max ports density:
  - 24 port/1U for copper
  - 96 FO fibers (for LCd)
- Full range of connectors:
  - RJ45 – Cat.5u/s, Cat.6u/s, Cat.6Au/s
  - LCd, LCq, E2000, SC, SCd. – MM/SM

# SD 6x RJ45 module, unequipped

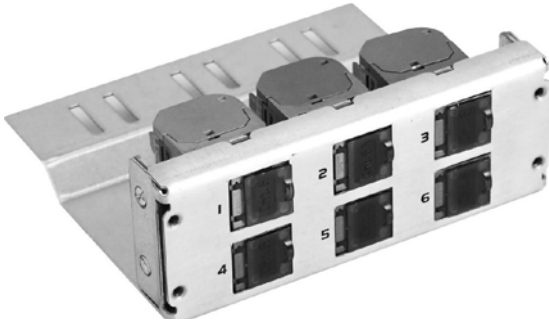

## TECHNICAL SPECIFICATIONS

|                          |                                 |
|--------------------------|---------------------------------|
| <b>Case material</b>     | Stainless steel                 |
| <b>Colour</b>            | Front: chrome-plated steel      |
|                          | Closure: Black RAL 9005         |
| <b>Temperature range</b> | -40°C to +70°C                  |
| <b>Protection level</b>  | IP20 (according to PN-EN 60529) |
| <b>Weight [kg]</b>       | 0.12                            |

## Ordering information

| Code                 | Description           |
|----------------------|-----------------------|
| <b>XB100.2SD.MCU</b> | SD module, unequipped |

### Description

- SD patch panel is the most flexible platform for serve either copper or FO connection. It can be equipped up to 24 RJ45 ports of Cat5-Cat6A or up to 96 fibers terminated with wide range of connectors LC/E2000/SC. Patch panel has 8 empty slots which can be equipped with copper holder (6x RJ45) or fully equipped FO cassettes spliced or for pre-terminated connectors including MPO/MTP connectors.

### Applications

- Nodal points of fiber optic networks
- Distribution points of fiber optic networks
- Server rooms

### Features

- Modular configuration system:
  - One-port modularity
  - Full range of connectors: RJ45 – Cat.5u/s, Cat.6u/s, Cat.6Au/s
  - Mounting: keystone
  - Port numbering
- Specifically designed place to cable mounting
- Capacity: up to 6x RJ45
- Capacity in SD panel: up to 4 modules
- Flip cover with a labelling sticker

# SD patch panel accessories

## Blind cover 0.5U

Blind cover for front of SD patch panel



| DIMENSIONS  |     |
|-------------|-----|
| Length [mm] | 220 |
| Width [mm]  | 129 |
| Height [mm] | 35  |

| ORDERING INFORMATION |                  |
|----------------------|------------------|
| <b>XB100.2SD.PPZ</b> | Blind cover 0.5U |

## Blind cover 1U

Blind cover for rear of SD patch panel



| DIMENSIONS  |     |
|-------------|-----|
| Length [mm] | 220 |
| Width [mm]  | 129 |
| Height [mm] | 35  |

| ORDERING INFORMATION |                |
|----------------------|----------------|
| <b>XB100.2SD.PTZ</b> | Blind cover 1U |

## Cable gland holder for SD patch panel

Cable gland holder for SD Patch panel. Holder can be installed to rear side of panel. It enables to fix 2 cable glands of  $\Phi$  xx



| DIMENSIONS  |     |
|-------------|-----|
| Length [mm] | 220 |
| Width [mm]  | 129 |
| Height [mm] | 35  |

| ORDERING INFORMATION |                    |
|----------------------|--------------------|
| <b>XB100.2SD.PTD</b> | Cable gland holder |

## Cable holder for SD panel

Cable holder enables fixation of cables/tubes which enter SD patch panel. Occupies one rear slot.



| DIMENSIONS  |     |
|-------------|-----|
| Length [mm] | 220 |
| Width [mm]  | 129 |
| Height [mm] | 35  |

| ORDERING INFORMATION |                |
|----------------------|----------------|
| <b>XB100.2SD.PTT</b> | Blind cover 1U |

## Cable holder for SD panel, double

Cable holder intended for fixation of multitube cables. Enables easy installation and distribution tubes within the space of SD patch panel



| DIMENSIONS  |     |
|-------------|-----|
| Length [mm] | 220 |
| Width [mm]  | 129 |
| Height [mm] | 35  |

| ORDERING INFORMATION |                |
|----------------------|----------------|
| <b>XB100.2SD.PTT</b> | Blind cover 1U |

## 19" cable organizer

To arrange cables in SD patch panel. Equipped with a flip cover with a sticker that facilitates markings



| DIMENSIONS  |         |
|-------------|---------|
| Depth [mm]  | 69.5    |
| Width [mm]  | 482     |
| Height [mm] | 44 (1U) |

| ORDERING INFORMATION |                     |
|----------------------|---------------------|
| <b>XB100.2SD.ORG</b> | 19" cable organizer |

# Voice panels



## Patch panels

### Description

→ FIBRAINDATA Structural Cabling Voice System, fully satisfies the requirements of cat 3 (class C) in accordance with standards ISO/IEC 11801, EN 50173 and ANSI/TIA/EIA 568-C.2. This series is dedicated for structured cabling installations, for digital and analog telephone signals transmissions. VOICE products offers good transmission parameters need for voice applications, easy connectorization of cables and convenience of use. Also all components of the transmission line complete ROHS 2002/95/WE Directive. Additional asset is certainty of connection using standard RJ45-RJ45 cables. Patch panels Voice series fully meet demands Cat.3 and provide digital and analog telephone signals transmissions. Contain 4 pins (2 pairs) IDC-LSA and offers fast and easy installation. Main body designed in L-type shelf. Quick and simple access to IDC for better restoration and eventual link reconnection. Panel front was equipped in description fields with pre-printed identification.

### ELECTRICAL AND MECHANICAL PARAMETERS

|                                |  |
|--------------------------------|--|
| <b>Frame</b>                   | 1.5 mm steel sheet   |
| <b>Jacket</b>                  | Non-shielded RJ45 Cat.3  |
| <b>Housing</b>                 | UL94V-0 black thermoplastic  |
| <b>Contact material</b>        | phosphor-bronze  |
| <b>Contacts</b>                | 0.35 mm diameter covered with 0.75 µm gold and 1.3 µm nickel layer |
| <b>Jack durability</b>         | >750 connection cycles in accordance with EN60603-7                |
| <b>IDC connector</b>           | IDC LSA  |
| <b>Wire diameter</b>           | 0.4-0.65 mm (AWG26-22)   |
| <b>IDC durability</b>          | >200 connection cycles   |
| <b>Coupler material</b>        | phosphor-bronze  |
| <b>Coupler coating</b>         | Brass Sn 60% Pb 40%  |
| <b>Sequence identification</b> | T568A and T568B  |

### Applications

- PBX
- Point-to-Point
- Token Ring4 Mbit/s
- ATM LAN 51.84 Mbit/s
- ATM LAN 155.52 Mbit/s
- Analog and digital transmission of phone signals

### Features

- 1U high, 19" for 25 and 50 ports
- ISDN 4-poles (3/6, 4/5)
- L-type shelf construction
- Quick and simple access to IDC
- Description fields with pre-printed identification

### Ordering information

| Code             | Description                                   |
|------------------|---|
| <b>XV100.200</b> | Patch Panel FIBRAINDATA voice series 25 ports |
| <b>XV100.210</b> | Patch Panel FIBRAINDATA voice series 50 ports |

# COPPER

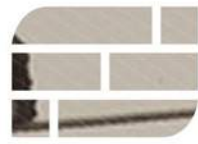

# FIBRAINDATA

## PATCH CORDS

Our solutions ensure stable and secure transmission

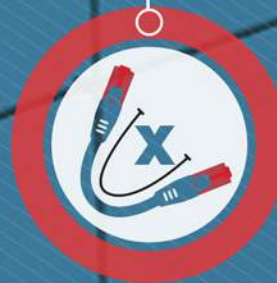

### PATCH CORD CABLE LENGTH

Various cable lengths and solutions are available



### PAIR SEPARATION

Connectors equipped with X pair separators ensure pair twisting to RJ45 clamp



### BENDING RADIUS PROTECTION

Patch cord cables equipped with a bending radius-limiting system



### CABLE COLOUR

Patch cord cables are available in 9 colours



# PATCH CORDS

**UTP**

**UNSHIELDED  
PATCH CORD**



## 5 BOOT COLOURS

Patch cord cable identification by cable colour or boot colour

**450  
MHz**



## 450MHz U/UTP CAT.6

Patch cord cables manufactured with the use of U/UTP 450MHz LSZH cat. 6

**FTP**

**SHIELDED  
PATCH CORD**



## 5 CABLE IDENTIFICATION STEPS

Additional colour coding elements: icons, cable, connector, boot and strain relief

**900  
MHz**



## 900MHz S/FTP CAT. 7

Patch cord cables manufactured with the use of S/FTP 900MHz FR-LSZH cat. 7



## MADE IN POLAND

Patch cord cable manufacturing in Advanced Technology & Manufacturing Center in Zaczerwie

# Patch cords Cat.5e

## Copper cabling



### Patch cord Cat.5e unshielded

Manufacturing technology

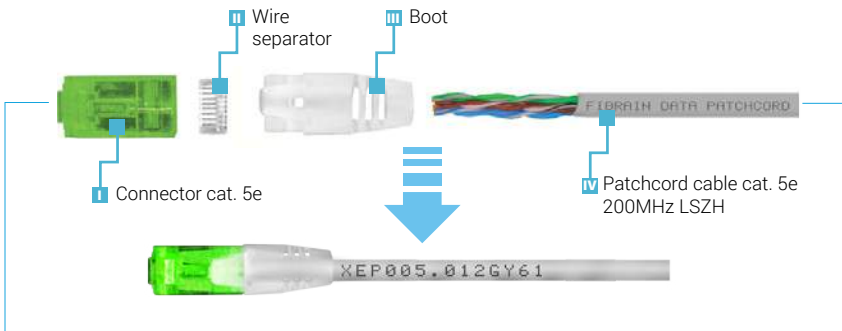

### ! UTP Distinctive features



Bending radius reduction system



Cable frequency – 200MHz

#### ❖ Applications

- Connection to a user's point
- Connection to a consolidation point
- Supplied in Data Center and consolidation points
- Complete transmission channel



### Ordering syntax

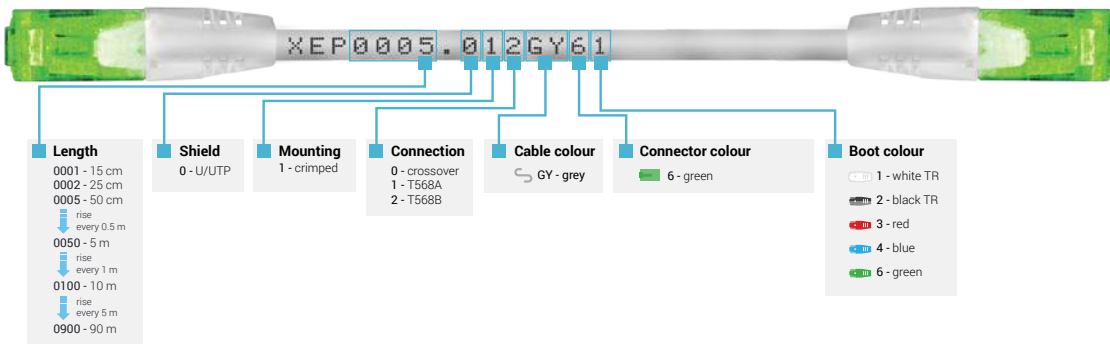

### Patch cord Cat.5e shielded

Manufacturing technology

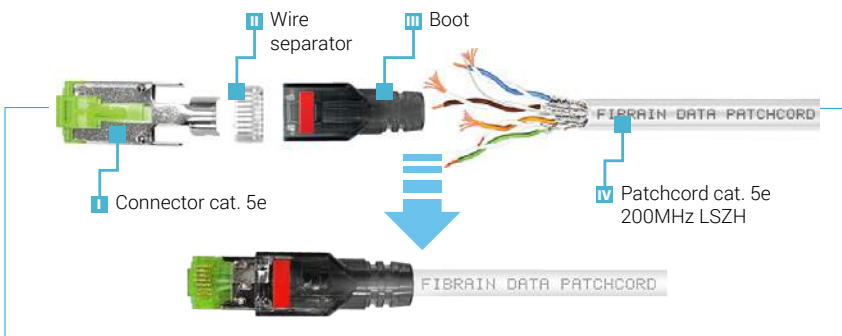

### ! FTP/STP Distinctive features



Bending radius reduction system



Cable frequency – 200MHz

#### ❖ Applications

- Connection to a user's point
- Connection to a consolidation point
- Supplied in Data Center and consolidation points
- Complete transmission channel



### Ordering syntax

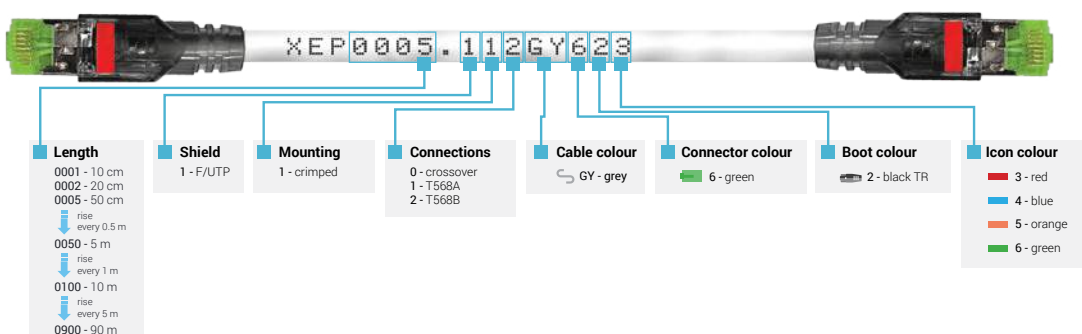



## Standard manufacturing

### Unshielded

| Cable colour  | Length |                 |
|---|--------|-----------------|
| <br>grey | 0.5 m  | XEP0050.012GY61 |
|   | 1 m    | XEP0100.012GY61 |
|   | 2 m    | XEP0200.012GY61 |
|   | 3 m    | XEP0300.012GY61 |
|   | 5 m    | XEP0500.012GY61 |
|   | 10 m   | XEP1000.012GY61 |

### Shielded

| Cable colour   | Length |                  |
|--|--------|------------------|
| <br>grey | 0.5 m  | XEP0050.112GY623 |
|  | 1 m    | XEP0100.112GY623 |
|  | 2 m    | XEP0200.112GY623 |
|  | 3 m    | XEP0300.112GY623 |
|  | 5 m    | XEP0500.112GY623 |
|  | 10 m   | XEP1000.112GY623 |

### Features

- Possibility of performing specifically designed solution to manage the infrastructure on a physical structure
- Made by FIBRAIN with the use of patented components which comply with all necessary mechanical Standards in ANSI/ICESA S - 102-732-2009
- Twisted cable pairs ensure full compatibility with dynamic parameters for the dedicated line and transmission channel in accordance with ISO/IEC 11801:2011, EN501732011
- Durable elements ensure number of cycles in accordance with IEC 60603-7-x, TIA/EIA 568-0.2
- Clear marking elements of structured cabling system in order to use solid system,
- Wire separator

# Patch cords Cat.6

## Copper cabling



### Patch cord Cat.6 unshielded

Manufacturing technology

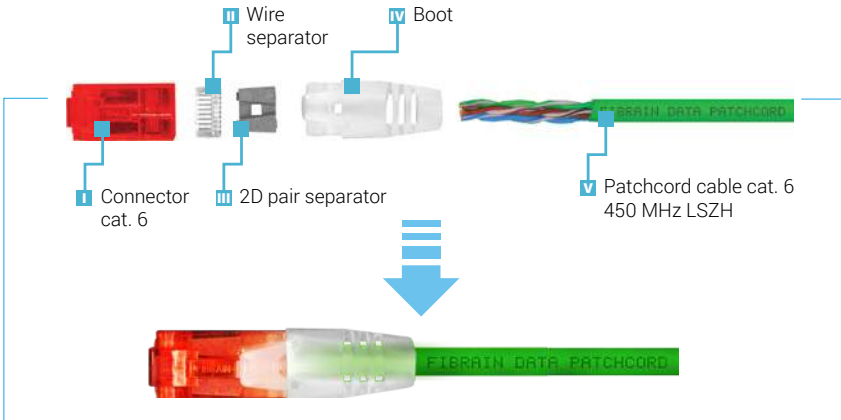

Bending radius reduction system



Cable frequency > Cat.6+



10Gbps bandwidth



2D Cross technology

#### Applications

- Connection to a user's point
- Connection to a consolidation's point
- Supplied in Data Center and consolidation points
- Complete transmission channel



### Ordering syntax

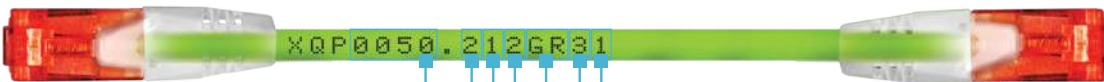

| Length   | Shield    | Mounting    | Connections                             | Cable colour   | Connector colour | Boot colour  |
|--|-----------|-------------|---|--|------------------|--|
| 0010 - 10 cm<br>0020 - 20 cm<br>0050 - 50 cm<br>rise every 0.5 m<br>0500 - 5 m<br>rise every 1 m<br>1000 - 10 m<br>rise every 5 m<br>9000 - 90 m | 0 - U/UTP | 1 - crimped | 0 - crossover<br>1 - T568A<br>2 - T568B | Y - yellow<br>GR - green<br>GY - grey<br>BL - blue<br>BK - black<br>R - red<br>W - white | 3 - red          | 1 - white TR<br>2 - black TR<br>3 - red<br>4 - blue<br>6 - green |



### Patch cord Cat.6 shielded

Manufacturing technology

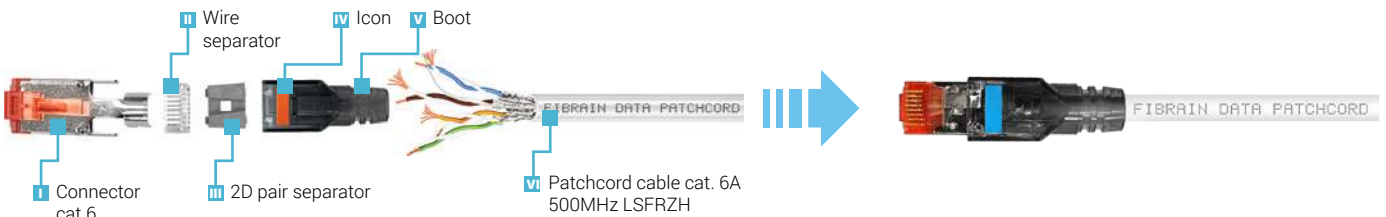

### Ordering syntax



| Length   | Shield    | Mounting    | Connections                             | Cable colour           | Connector colour | Boot colour  | Icon colour                                    |
|--|-----------|-------------|---|------------------------|------------------|--------------|--|
| 0010 - 10 cm<br>0020 - 20 cm<br>0050 - 50 cm<br>rise every 0.5 m<br>0500 - 5 m<br>rise every 1 m<br>1000 - 10 m<br>rise every 5 m<br>9000 - 90 m | 2 - S/FTP | 1 - crimped | 0 - crossover<br>1 - T568A<br>2 - T568B | GY - grey<br>W - white | 3 - red          | 2 - black TR | 3 - red<br>4 - blue<br>5 - orange<br>6 - green |



## Standard manufacturing

### Unshielded

| Cable colour   | Length |                 |
|--|--------|-----------------|
| <br>green | 0.5 m  | XQP0050.012GR31 |
|  | 1 m    | XQP0100.012GR31 |
|  | 2 m    | XQP0200.012GR31 |
|  | 3 m    | XQP0300.012GR31 |
|  | 5 m    | XQP0500.012GR31 |
|  | 10 m   | XQP1000.012GR31 |

### Shielded

| Cable colour  | Length |                 |
|---|--------|-----------------|
| <br>white | 0.5 m  | XQP0050.212W324 |
|   | 1 m    | XQP0100.212W324 |
|   | 2 m    | XQP0200.212W324 |
|   | 3 m    | XQP0300.212W324 |
|   | 5 m    | XQP0500.212W324 |
|   | 10 m   | XQP1000.212W324 |

### Features

- Possibility of performing specifically designed solution to manage the infrastructure on a physical structure
- Made by FIBRAIN with the use of patented components which comply with all necessary mechanical Standards in ANSI/ICESA S - 102-732-2009
- Twisted cable pairs ensure full compatibility with dynamic parameters for the dedicated line and transmission channel in accordance with ISO/IEC 11801:2011, EN501732011
- Durable elements ensure a number of cycles in accordance with IEC 60603-7-x, TIA/EIA 568-0.2
- Clear marking elements of structured cabling system in order to use a solid system,
- 2D pair separator
- Wire separator

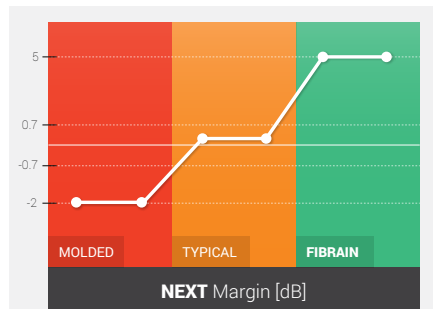

Advanced system of connector's termination with pair separation system from a place of outer jacket- improved dynamic parameters

# Patch cords Cat.6<sub>A</sub> shielded

**FIBRAINDATA Patch cord Cat.6A shielded**  
Patch cord cable 900 MHz Cat.7



## Patch cord Cat.6A shielded

Manufacturing technology

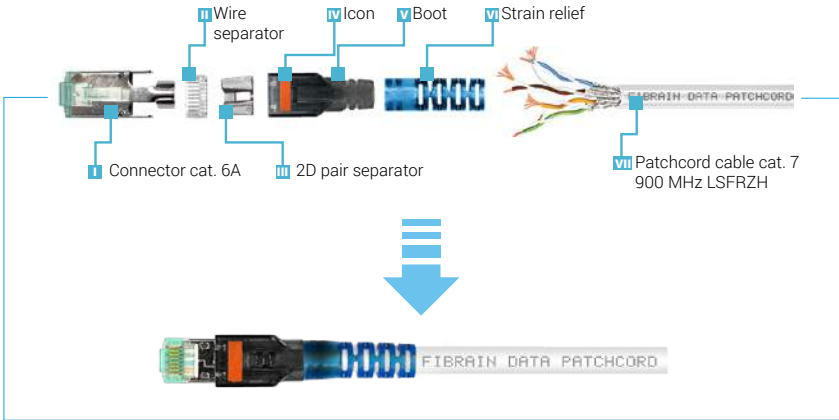

### ! FTP/STP Distinctive features

- 5** 5 cable identification steps
- Bending radius reduction system**
- 10 Gbps** 10Gbps bandwidth
- 2D Cross technology**

### ❖ Applications

- Connection to a user's point
- Connection to a consolidation point
- Supplied in Data Center and consolidation points
- Complete transmission channel



## Ordering syntax



| Length   | Shield    | Mounting    | Connections                             | Cable colour  | Connector colour | Boot colour  | Icon colour                                    | Strain relief colour  |
|--|-----------|-------------|---|---|------------------|--------------|--|---|
| 0010 - 10 cm<br>0020 - 20 cm<br>0050 - 50 cm<br>rise every 0.5 m<br>0500 - 5 m<br>rise every 1 m<br>1000 - 10 m<br>rise every 5 m<br>9000 - 90 m | 4 - S/FTP | 1 - crimped | 0 - crossover<br>1 - T568A<br>2 - T568B | Y - yellow<br>GR - green<br>GY - grey<br>BL - blue<br>BK - black<br>R - red<br>W - white<br>AQ - aqua<br>V - violet | 7 - aqua         | 2 - black TR | 3 - red<br>4 - blue<br>5 - orange<br>6 - green | 1 - white TR<br>2 - black TR<br>3 - red TR<br>4 - blue TR<br>6 - green TR |



## Standard manufacturing

Shielded

| Cable colour | Length |                   |
|--------------|--------|-------------------|
| green        | 0.5 m  | XRP0050.412GR7262 |
|              | 1 m    | XRP0100.412GR7262 |
|              | 2 m    | XRP0200.412GR7262 |
|              | 3 m    | XRP0300.412GR7262 |
|              | 5 m    | XRP0500.412GR7262 |
|              | 10 m   | XRP1000.412GR7262 |



# COPPER



# FIBRAINDATA

## ELECTRO & INSTALLATION

solutions meeting ever-increasing market requirements

45  
x  
45

FRENCH STYLE  
STANDARD



FLUSH & WALL MOUNT BOXES



1-6 MODULES  
IN A SINGLE FRAME



ANGLED AND FLAT  
DESIGN



MODULAR DESIGN

50  
x  
50

BRITISH STYLE  
STANDARD



3 TYPES OF DEPTH



1-4 MODULES  
IN A SINGLE FRAME



COPPER AND FO  
FACEPLATES



MODULAR DESIGN



# TERMINATION OUTLETS ACCESSORIES

and standards



**Flush mount boxes**



**2-module**  
GIP-2



**4-module**  
GIP-4



**6-module**  
GIP-6

**Wall mount boxes**



**2-module**  
OBU-2



**4-module**  
OBU-4

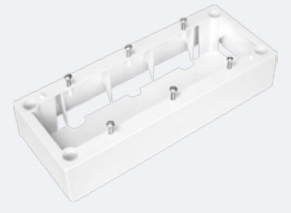

**6-module**  
OBU-6

**Mounting supports**



**SUP-2** 45x45 mm 2-module mounting support

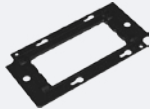

**SUP-4** 90x45 mm 4-module mounting support

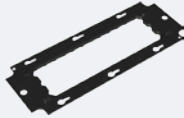

**SUP-6** 135x45 mm 6-module mounting support

**Mounting frame**



**RAM-2** frame designed for 45x45mm 2-support module





**RAM-4** frame designed for 90x45mm 4-support module



**RAM-6** frame designed for 135x45mm 6-support module

**Flat faceplates**

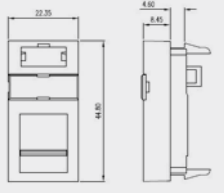
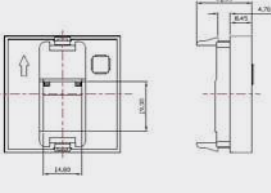
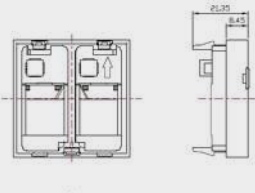
| XB-45KA00S-01   | XB-45KA00D-01   | XB-45KA00D-02   |
|---|---|---|
|  |  |  |
|  |  |  |



**Angle construction**



**45 mm dimension**





**Coloured identifying icons**

**Features**

- 45x45 mm mounting
- Flat construction
- Description field and identification icons
- Anti-dust protection
- Termination 1 or 2 modules in keystone standard
- Termination any FIBRAINDATA keystone module
- Packing - easy-open bags with clear marking
- Each adapter has set of identification icons in 2 colours and description field

**Flat faceplates**

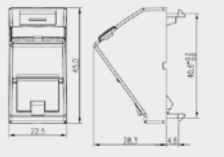
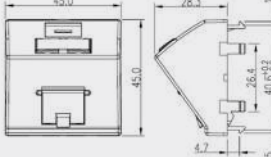
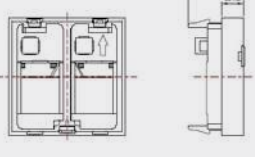
| XB-45KA45S-01   | XB-45KA45D-01   | XB-45KA45D-02   |
|---|---|---|
|  |  |  |
|  |  |  |

**Packing**

**Flat adapters**

- **XB-45KA00S-01** multipack 5x adapter, individual purchase available
- **XB-45KA00D-01** 1x adapter
- **XB-45KA00D-02** 1x adapter

**Angled adapters**

- **XB-45KA45S-01** 1x adapter
- **XB-45KA45D-01** 1x adapter
- **XB-45KA45D-02** 1x adapter

# French style system 45x45

## Termination outlets

### Blind cover



**XB-45000S-01** blind adapter - 22.5 x 45 mm









**XB-45000D-02** blind adapter - 45 x 45 mm

#### Features

- Designed to cover unused areas when constructing logic points
- To be mounted with frames equipped with supports
- Mounted with a clip

### Electrical socket

| Type  | Single  | Double  | Triple  |
|---|---|---|---|
| <b>2P+Z electrical red socket with blocking mechanism</b> | <br>XB-45PU00S-01-K | <br>XB-45PU00D-02-K | <br>XB-45PU00T-03-K |
| <b>2P+Z white electrical socket</b>                       | <br>XB-45PU00S-01  | <br>XB-45PU00D-02  | <br>XB-45PU00T-03  |
| <b>XB-45PUKEY</b><br>Unlock key                           |                    |   |   |

#### Features

- Facilitate building integrated electro-logic point
- 240 V 50 Hz / 16 A with a grounding screw
- Mounted with a clip

Complete Data and Electrical Termination outlet

**Wall mount boxes**



**XB-50BBA-02**  
2-module 86 x 86 x 27 mm

**XB-50BBB-02**  
2-module 86 x 86 x 32 mm

**XB-50BBC-02**  
2-module 86 x 86 x 37 mm



**XB-50BBA-04**  
4-module 86 x 146 x 27 mm

**XB-50BBB-04**  
4-module 86 x 146 x 32 mm

**XB-50BBC-04**  
4-module 86 x 146 x 37 mm

**Mounting frames**

Angular option



**XB-50FPB-0002**  
Frame with support 2-module 50 x 50 mm



**XB-50FPB-0004**  
4-module 100 x 50 mm

Flat option



**XB-50FPF-0002**  
Frame with support 2-module 50 x 50 mm

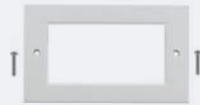

**XB-50FPF-0004**  
4-module 100 x 50 mm

**Faceplates 25x50**



**XB-50KA45I-01**  
25 x 50 mm angular adapter designed for keystone module



**XB-50SC45I-01**  
25 x 50 mm adapter designed for SC- SX connection



**XB-50BL000-01**  
25 x 50 mm blind adapter



**XB-50ST45I-01**  
25 x 50 mm angular adapter designed for ST SX connection



**XB-50KA00L-01**  
25 x 50 mm flat adapter designed for keystone module

**Faceplates 86x86**



**XB-50FPF-0102**  
frame with support for 1 keystone module



**XB-50FPF-0202**  
for 2 keystone modules

**Complete Data Termination outlet**

**American Faceplate**



**XB-USFPF-A01**  
for 1 keystone module



**XB-USFPF-A02**  
for 2 keystone module



**XB-USFPF-A04**  
for 4 keystone module



**XB-USFPF-A06**  
for 6 keystone module

**Wall mount boxes**



**XB-USBB**  
Wall mount box for US style faceplates for 1/2/4/6 keystone connection modules

**Surface mount boxes**

Wall mount module



**XB-00BXIL-01**  
Wall-mount 1x keystone



**XB-00BXIL-02**  
Wall-mount 2x keystone

**Special designed adapters**

Adapter designed for Legrand Valena frame

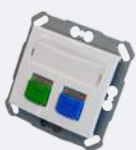

**XB-LVKA00S-02**  
Adapter designed for Legrand Valena frame 2x keystone

Din-Rail adapter



**XB-DNKA45-A1**  
Din – Rail adapter designed for 1 keystone module with grounding

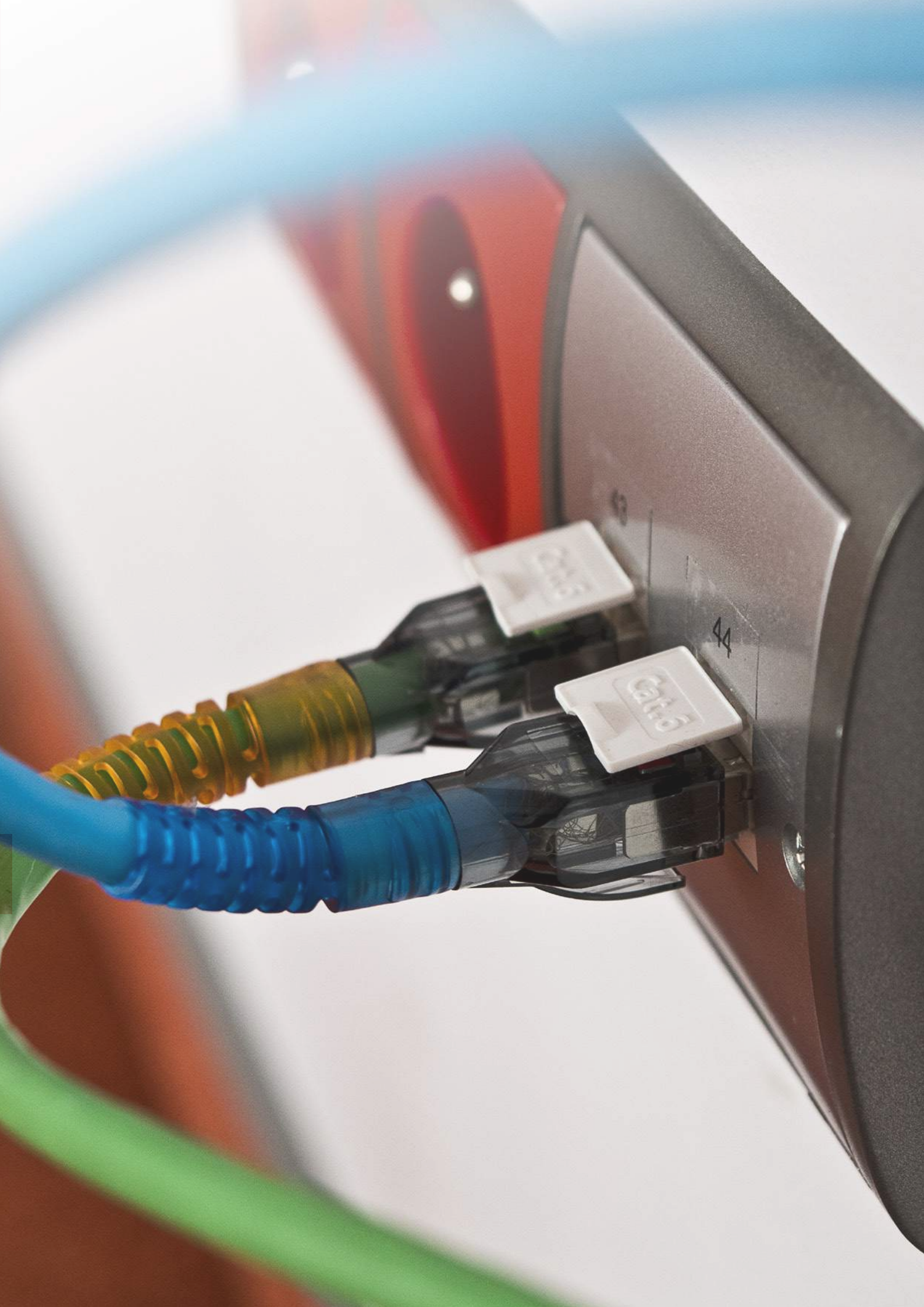



FIBRAINDATA

# CABINETS

Suitable protection of teleinformatics infrastructure



**SRS**  
SRS STANDING  
CABINETS



**MOUNTING HEIGHT**  
21-45U



**DEPTH**  
600/800/1000 mm



**BLACK CABINETS**  
RAL 9005



**GLASS FRONT DOOR**



**LOAD CAPACITY**  
max. 1000 kg



**SSRS**  
SSRS STANDING  
CABINETS



**STANDARD HEIGHT**  
45U



**DEPTH**  
1000/1200 mm



**PERFORATED  
CONSTRUCTION**



**LOAD CAPACITY**  
1360 kg



# CABINETS

**SWJ**

WALL MOUNT  
SINGLE SECTION  
SWJ CABINETS

18U  
6U

MOUNTING HEIGHT  
6-18U

400  
600  
mm

DEPTH  
400/600 mm



ONE SOLID CONSTRUCTION



LOAD CAPACITY  
max. 100 kg

**SWD**

WALL MOUNT  
TWO SECTION  
SWD CABINETS

18U  
6U

MOUNTING HEIGHT  
6-18U

500  
mm

DEPTH  
500 mm



TWO PART SOLID  
CONSTRUCTION



LOAD CAPACITY  
max. 30 kg



VERTICAL CABLE  
ORGANIZER



HORIZONTAL CABLE  
ORGANIZER



CABLE  
ORGANIZERS

# SRS Floor Standing Network Cabinets

|     |                  |       |        |                |
|-----|------------------|-------|--------|----------------|
| 21U | SRS-21-6/6-S04-B |       |        |                |
|     | Width            | Depth | Height | Load cap. [kg] |
|     | 600              | 600   | 1095   | 300            |
| 24U | SRS-24-6/6-S04-B |       |        |                |
|     | Width            | Depth | Height | Load cap. [kg] |
|     | 600              | 600   | 1210   | 600            |
| 24U | SRS-24-6/8-S04-B |       |        |                |
|     | Width            | Depth | Height | Load cap. [kg] |
|     | 600              | 800   | 1210   | 600            |
| 27U | SRS-27-6/6-S04-B |       |        |                |
|     | Width            | Depth | Height | Load cap. [kg] |
|     | 600              | 600   | 1315   | 600            |
| 27U | SRS-27-6/8-S04-B |       |        |                |
|     | Width            | Depth | Height | Load cap. [kg] |
|     | 600              | 800   | 1315   | 600            |
| 32U | SRS-32-6/6-S04-B |       |        |                |
|     | Width            | Depth | Height | Load cap. [kg] |
|     | 600              | 600   | 1535   | 600            |
| 32U | SRS-32-6/8-S04-B |       |        |                |
|     | Width            | Depth | Height | Load cap. [kg] |
|     | 600              | 800   | 1535   | 600            |
| 32U | SRS-32-8/8-S04-B |       |        |                |
|     | Width            | Depth | Height | Load cap. [kg] |
|     | 800              | 800   | 1535   | 600            |



|     |                   |       |        |                |
|-----|-------------------|-------|--------|----------------|
| 42U | SRS-42-6/6-S04-B  |       |        |                |
|     | Width             | Depth | Height | Load cap. [kg] |
|     | 600               | 600   | 1980   | 600            |
| 42U | SRS-42-6/8-S04-B  |       |        |                |
|     | Width             | Depth | Height | Load cap. [kg] |
|     | 600               | 800   | 1980   | 600            |
| 42U | SRS-42-8/8-S04-B  |       |        |                |
|     | Width             | Depth | Height | Load cap. [kg] |
|     | 800               | 800   | 1980   | 600            |
| 42U | SRS-42-6/10-S04-B |       |        |                |
|     | Width             | Depth | Height | Load cap. [kg] |
|     | 600               | 1000  | 1980   | 600            |
| 42U | SRS-42-8/10-S04-B |       |        |                |
|     | Width             | Depth | Height | Load cap. [kg] |
|     | 800               | 1000  | 1980   | 600            |
| 45U | SRS-45-8/10-S04-B |       |        |                |
|     | Width             | Depth | Height | Load cap. [kg] |
|     | 800               | 1000  | 2120   | 600            |
| 45U | SRS-45-8/10-S04-B |       |        |                |
|     | Width             | Depth | Height | Load cap. [kg] |
|     | 800               | 1000  | 2120   | 600            |

## Features

- Individual configuration:
  - multiple door, panel, roof options for maximum flexibility,
  - possibility to join cabinets in a row
  - levelling feet, castor or plinth options
  - individual configuration using simple coding.
- Wide range of supplementary accessories: shelves, drawers, fan units, power strips, blanking plates etc.
- Flexibility in manufacturing tailor-made cabinets
- Material:
  - frame, side panels, solid steel door, roof, mounting profiles,
  - C-profiles - sheet steel
- Protection degree: IP 20 in accordance with EN 60529 (does not apply to brush cable entries)
- Surface finishing: Frame, roof, panels, doors, plinth - powder paint, black (RAL 9005). All other color options on request. Mounting profiles, C-profiles - Al-Zn coated

## Assembly set

- frame,
- safety glass front door,
- two side panels,
- steel rear door shortened with 3 U module panel with brush strip, lockable,
- standard roof, raised, with perforated sides,
- 2 pairs of 19" mounting profiles,
- earthing bar and cables,
- cabinet placed on levelling feet.

## Delivery

Cabinets are delivered as fully assembled items in a secure portable carton on a wooden pallet

## MAXIMUM WEIGHT OF EQUIPMENT MOUNTED IN CABINET

|                    |          |
|--------------------|----------|
| Levelling feet     | 1000 kg  |
| Castors - type 150 | 150 kg   |
| Castors - type 300 | 500 kg   |
| Plinth             | 1000 kg* |

# SSRS Floor standing server cabinets

| SSRS-42-6/10-S04-B |       |       |        |               |
|--------------------|-------|-------|--------|---------------|
| 42U                | Width | Depth | Height | Load cap.[kg] |
|                    | 600   | 1000  | 1980   | 1000          |

| SSRS-42-8/10-S04-B |       |       |        |               |
|--------------------|-------|-------|--------|---------------|
| 42U                | Width | Depth | Height | Load cap.[kg] |
|                    | 800   | 1000  | 1980   | 1000          |

| SSRS-42-8/12-S04-B |       |       |        |               |
|--------------------|-------|-------|--------|---------------|
| 42U                | Width | Depth | Height | Load cap.[kg] |
|                    | 800   | 1200  | 1980   | 1000          |

| SSRS-45-6/10-S04-B |       |       |        |               |
|--------------------|-------|-------|--------|---------------|
| 45U                | Width | Depth | Height | Load cap.[kg] |
|                    | 600   | 1000  | 1980   | 1000          |

| SSRS-45-8/10-S04-B |       |       |        |               |
|--------------------|-------|-------|--------|---------------|
| 45U                | Width | Depth | Height | Load cap.[kg] |
|                    | 800   | 1000  | 1980   | 1000          |

| SSRS-45-8/12-S04-B |       |       |        |               |
|--------------------|-------|-------|--------|---------------|
| 45U                | Width | Depth | Height | Load cap.[kg] |
|                    | 800   | 1200  | 1980   | 1000          |

## Features

- Expanded configuration system:
  - multiple door, panel, roof options for maximum flexibility,
  - possibility to join cabinets in a row,
  - possibility of optional cable entry,
  - easy coding system enables quick configuration of the cabinet.
- Possibility of controlling ventilating air flow by application of proper type of doors, side panels and fan units.
- Wide range of supplementary accessories: shelves, drawers, fan units, power strips, blanking plates etc.
- Non-standard cabinets are available on individual customer's request.
- Material:
  - Frame, side panels, doors, roof, mounting profiles, C-profiles - sheet steel
  - Outriggers - zamak casting
- Protection degree: IP 20 in accordance with EN 60529 (does not apply to brush cable entries).
- Surface finishing: Frame, roof, panels, doors - powder paint, light grey (RAL 7035) or black (RAL 9005). All other color options on request. Mounting profiles, C-profiles - Al-Zn coated.

## Assembly set

- cabinet frame,
- perforated front and rear steel door (perforation type C), with three-point rod-latch lock with swing handle,
- two side panels made of unperforated steel sheets,
- standard roof (with 1 or 3 cable openings covered with knock-out blanking plates):
  - 600 mm cabinets – 1 opening,
  - 800 mm cabinets – 3 openings;
  - • three pairs of mounting profiles, spaced at 19",
  - • earthing strip and cables,
  - • levelling feet.

## Delivery

Cabinets are delivered as fully assembled items in a secure portable carton on a wooden pallet

## MAXIMUM WEIGHT OF EQUIPMENT MOUNTED IN CABINET

|                    |          |
|--------------------|----------|
| Levelling feet     | 1360 kg* |
| Castors - type 300 | 500 kg   |
| Plinth             | 1360 kg* |

\*Declared carrying capacity is valid if maintaining the maximum distance between mounting profiles within the cabinet. If the cabinet is set on feet, for ensuring carrying capacity you must also tighten jam nuts to the bottom plate.



# SWJ Wall mount single section cabinets

| SWJ-06-400-S04-B |       |       |        |
|------------------|-------|-------|--------|
| 6U               | Width | Depth | Height |
|                  | 600   | 400   | 365    |
| SWJ-10-400-S04-B |       |       |        |
| 10U              | Width | Depth | Height |
|                  | 600   | 400   | 543    |
| SWJ-12-400-S04-B |       |       |        |
| 12U              | Width | Depth | Height |
|                  | 600   | 400   | 632    |
| SWJ-15-400-S04-B |       |       |        |
| 15U              | Width | Depth | Height |
|                  | 600   | 400   | 765    |
| SWJ-18-400-S04-B |       |       |        |
| 18U              | Width | Depth | Height |
|                  | 600   | 400   | 899    |
| SWJ-06-600-S04-B |       |       |        |
| 6U               | Width | Depth | Height |
|                  | 600   | 600   | 365    |
| SWJ-10-600-S04-B |       |       |        |
| 10U              | Width | Depth | Height |
|                  | 600   | 600   | 543    |
| SWJ-12-600-S04-B |       |       |        |
| 12U              | Width | Depth | Height |
|                  | 600   | 600   | 632    |
| SWJ-15-600-S04-B |       |       |        |
| 15U              | Width | Depth | Height |
|                  | 600   | 600   | 765    |
| SWJ-18-600-S04-B |       |       |        |
| 18U              | Width | Depth | Height |
|                  | 600   | 600   | 899    |



## Features

- Designed for indoor applications
- Available in 2 depths (400 and 600 mm) and 6 usable heights (from 6 to 21 U)
- The cabinet is made of bolted framework (composed of 3 frames), top plate, bottom plate, side panels, rear panel and front door
- Cabinet is equipped with two adjustable 19" mounting profiles
- Top and bottom plates have cable openings covered with knock-out blanking plates, and 3 venting holes for each plate
- Door, side panels and mounting profiles can be installed without tools
- The entire weight of the devices installed inside the cabinet is transferred onto its framework. Top and bottom plates, side panels and cabinet door can be removed or installed also with a fully equipped cabinet that is mounted to the wall
- Side panels can be removed after opening the door
- With easy replacement of doors, side panels, top and bottom plates for a different color scheme, the cabinet design can be changed multiple times
- Material: sheet steel, safety glass
- Protection degree: IP 20 in accordance with EN 60529
- Protection degree of cabinet in basic version:
  - frame, doors, panels – powder paint, light grey (RAL 7035)
  - mounting profiles – Al-Zn coated
- Maximum load capacity: The maximum weight of equipment mounted in cabinet is 100 kg

## Assembly set

- 1x brush strip
- 1x set of M6 rack bolts(16 pcs)
- 2x keys for side and back wall
- 2x keys for front door
- 4x set of M10 leveling feet
- 1.5 m of special edge sheath protecting cabling (after a breaking cable grommet)

## Delivery

Cabinets are delivered as fully assembled items in a secure portable carton on a wooden pallet

# SWD Wall mount two section cabinets

## Cabinets

| SWD-06-500-S04-B |       |       |        |
|------------------|-------|-------|--------|
| 6U               | Width | Depth | Height |
|                  | 600   | 500   | 330    |
| SWD-10-500-S04-B |       |       |        |
| 10U              | Width | Depth | Height |
|                  | 600   | 500   | 464    |
| SWD-12-500-S04-B |       |       |        |
| 12U              | Width | Depth | Height |
|                  | 600   | 500   | 600    |
| SWD-15-500-S04-B |       |       |        |
| 15U              | Width | Depth | Height |
|                  | 600   | 500   | 730    |
| SWD-18-500-S04-B |       |       |        |
| 18U              | Width | Depth | Height |
|                  | 600   | 500   | 865    |



### Features

- Standard RAL 9005 colour (black - structure)
- IP20 protection
- Indoor use
- Wide range of additional accessories (pedestals, sockets, shelves, fan units, light units, light units, power distribution units, elements for installing and placing the cables)
- 2x holes in the top part and the bottom to install ventilation panel
- Zinc sheet pair of vertical 19" mounting profiles, mounted on horizontal profile rails with 25 mm hole spacing
- Maximum spacing between mounting profiles:
  - cabinet depth: 400 mm - 335 mm,
  - cabinet depth: 500 mm - 435 mm,
  - cabinet depth: 600 mm - 535 mm,
- Material: 1,25 mm thick steel sheet,
- Removable and lockable with single point lock side walls
- Front door with hardened glass (thickness: 3,15 mm) with single point lock, mounted on the hinges, opening angle 180° (optionally steel door)
- Left or right door opening options,
- 2x holes in the top part and bottom to insert cables (250 x 70 mm)
- Load capacity: 50 kg

### Assembly set

- 1x brush strip
- 1x set of M6 rack bolts(16 pcs)
- 2x keys for side and back wall
- 2x keys for front door
- 4x set of M10 leveling feet
- 1.5 m of special edge sheath protecting cabling (after a breaking cable grommet)

### Delivery

Cabinets are delivered as fully assembled items in a secure portable carton on a wooden pallet

# Cabinet accessories

## Cabinets

### 1U/ 19" shelf

RAL 9005

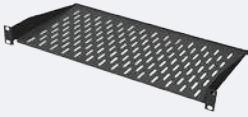

#### PSM-25-1U-S04-B

| Width [mm] | Depth [mm] | Load cap.[kg] |
|------------|------------|---------------|
| 446        | 250        | 10            |

#### Features

- Material: steel sheet
- Mounted at the front
- Colour: RAL 9005 black

### 1U/ 19" fixed shelf - mounted in 4 points

RAL 9005

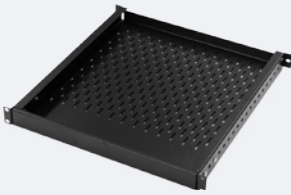

#### PSM-35-1U-S04-B

| Height [mm] | Width [mm] | Depth [mm] | Load cap.[kg] |
|-------------|------------|------------|---------------|
| 22          | 483        | 350        | 100           |

#### PSM-45-1U-S04-B

| Height [mm] | Width [mm] | Depth [mm] | Load cap.[kg] |
|-------------|------------|------------|---------------|
| 22          | 483        | 450        | 100           |

#### PSM-55-1U-S04-B

| Height [mm] | Width [mm] | Depth [mm] | Load cap.[kg] |
|-------------|------------|------------|---------------|
| 22          | 483        | 550        | 100           |

#### PSM-65-1U-S04-B

| Height [mm] | Width [mm] | Depth [mm] | Load cap.[kg] |
|-------------|------------|------------|---------------|
| 22          | 483        | 650        | 100           |

#### Features

- Material: steel sheet
- Mounted at the front and back in 4 points
- Colour: RAL 9005 black
- Adjustable back handles in a given mounting range

### 1U/19" Depth adjustable shelf

RAL 9005

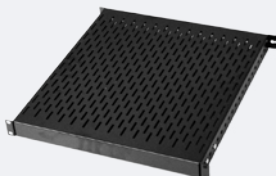

#### PSZ-60-1U-B

| Depth [mm] | Load cap.[kg] |
|------------|---------------|
| 350-600    | 150           |

#### PSZ-90-1U-B

| Depth [mm] | Load cap.[kg] |
|------------|---------------|
| 500-900    | 150           |

#### Features

- Steel sheet
- Mounted at the front or back
- Adjustable in depth every 25 mm
- Colour: RAL 9005 black

**Fan panels**

|                             | WTD-2T-S04-B<br>2-fan | WTD-4T-S04-B<br>4-fan |
|-----------------------------|-----------------------|-----------------------|
| Dimensions (W x D x H) [mm] | 119 x 119 x 38        | 119 x 119 x 38        |
| Ambient temperature [°C]    | from -10 to +70       | from -10 to +70       |
| Protection degree           | IP 20                 | IP 20                 |
| Capacity [m³/h]             | 330                   | 660                   |



**Features**

- Designed to be mounted in 19" cabinets
- Equipped with power protector
- Illuminated switch and thermostat with temperature control
- Material: steel sheet

**Fan panels designed for wall mount cabinets**



WTA-1W 1-fan module

**Features**

- Designed to be mounted in the top or bottom part of 19" wall mount cabinets
- Equipped with power supply cable, grounding cable and screws to mount fans
- Power supply: AC 230 V, 50 Hz

**Distribution unit**

| 3U | PDN-3U-B    |            |            |
|----|-------------|------------|------------|
|    | Height [mm] | Width [mm] | Depth [mm] |
|    | 133         | 446        | 60         |



**Features**

- 19" housing for modular devices
- 1.5 mm thick sheet powder painted
- Equipped with din rail with 402.5 x 45.5 mm opening
- Maximum quantity: 18 built-in modules S type (width: 17.5 mm)
- Material: 1.5 mm steel sheet

**Base designed for 19" server cabinet with integrated tilt protection**

| CKP-6/10-S04-B |            |             |             |               |
|----------------|------------|-------------|-------------|---------------|
| Width [mm]     | Depth [mm] | Height [mm] | Weight [kg] | Load cap.[kg] |
| 600            | 1000       | 100         | 23          | 100           |
| CKP-8/10-S04-B |            |             |             |               |
| Width [mm]     | Depth [mm] | Height [mm] | Weight [kg] | Load cap.[kg] |
| 800            | 1000       | 100         | 25.5        | 100           |
| CKP-8/12-S04-B |            |             |             |               |
| Width [mm]     | Depth [mm] | Height [mm] | Weight [kg] | Load cap.[kg] |
| 800            | 1200       | 100         | 25.5        | 100           |

**Features**

- Designed to be mounted with 19" cabinets
- Material: steel sheet
- Equipped with integrated tilt protection
- Can be used in combination with leveling feet



**Leveled base for 19" standing cabinet**

| Code           | Height [mm] | Width [mm] | Depth [mm] | Load cap.[kg] |
|----------------|-------------|------------|------------|---------------|
| CKR-6/6-S04-B  | 100         | 600        | 600        | 100           |
| CKR-6/8-S04-B  |             | 600        | 800        |               |
| CKR-8/6-S04-B  |             | 800        | 600        |               |
| CKR-8/8-S04-B  |             | 800        | 800        |               |
| CKR-6/10-S04-B |             | 600        | 1000       |               |
| CKR-8/10-S04-B |             | 800        | 1000       |               |
| CKR-8/12-S04-B |             | 800        | 1200       |               |

**Features**

- Designed to be mounted with SRS and SSRS 19" cabinets
- Leveling feet
- The set consists of the given elements that are ordered separately:
  - 100 mm base
  - 4 corners with leveling feet
  - 4 shackles (plain, perforated or with brush panel)



**Base designed for 19" standing cabinet**

| Code           | Height [mm] | Width [mm] | Depth [mm] | Load cap.[kg] |
|----------------|-------------|------------|------------|---------------|
| CKS-6/6-S04-B  | 100         | 600        | 600        | 100           |
| CKS-6/8-S04-B  |             | 600        | 800        |               |
| CKS-8/6-S04-B  |             | 800        | 600        |               |
| CKS-8/8-S04-B  |             | 800        | 800        |               |
| CKS-6/10-S04-B |             | 600        | 1000       |               |
| CKS-8/10-S04-B |             | 800        | 1000       |               |
| CKS-8/12-S04-B |             | 800        | 1200       |               |

**Features**

- Designed to be mounted with SRS 19" cabinets
- Can be used in combination with leveling feet or wheels
- Perforated front plate
- Base height can be increased to 200 mm by screwing two bases together





# Cable arrangement

## Cabinets

### 19" Horizontal cable organizer

with easily-opened plastic handles

ORG-VP-1U-B-V2



Clip



4-6 holders



Horizontal organizer

#### Features

- 19" mounting
- Powder painted steel
- Equipped with 4 easily opened-handles
- Possibility of installing 2 extra handles
- Clear manufacturer marking
- Possibility of using together with vertical organizers
- Guarantee optimum cable arrangement

### 19" Vertical cable organizer

with easily-opened plastic handles

ORG-HP-1U-B-V2



Clip



4 holder positions



Vertical organizer

#### Features

- 1U mounting
- Powder painted steel
- Equipped with 1 easily opened-handle
- Possibility of using holder in 4 positions
- Clear manufacturer marking
- Guarantee optimum cable arrangement

### Velcro tape

16x200 10 pcs

#### FIBRAIN velcro tapes

ORG-CT-16200-BK  
black

ORG-CT-16200-W  
white



#### Features

- Material: velour
- Guarantee optimum cable arrangement
- Pack of 10 pcs
- Width: 16 mm- protected against excessive tightening
- Resistant to multiple opening and closing
- Colours facilitate cable identification

# Power distribution units

## Cabinets

| PDU-5BL                 |           |                |                      |
|-------------------------|-----------|----------------|----------------------|
| Qty and type of sockets | Plug      | Extra elements | Max. electrical load |
| 5 x Jacket with pin     | UNISCHUKO | LED switch     | 16 A (3680 W)        |
| PDU-8BL                 |           |                |                      |
| Qty and type of sockets | Plug      | Extra elements | Max. electrical load |
| 8 x Jacket with pin     | UNISCHUKO | LED switch     | 16 A (3680 W)        |
| PDU-9AB                 |           |                |                      |
| Qty and type of sockets | Plug      | Extra elements | Max. electrical load |
| 9 x Jacket with pin     | IEC320C14 | -              | 16 A (3680 W)        |
| PDU-9BB                 |           |                |                      |
| Qty and type of sockets | Plug      | Extra elements | Max. electrical load |
| 9 x Jacket with pin     | UNISCHUKO | -              | 16 A (3680 W)        |
| PDU-9SB                 |           |                |                      |
| Qty and type of sockets | Plug      | Extra elements | Max. electrical load |
| 9 x Jacket z SCHUKO     | UNISCHUKO | -              | 16 A (3680 W)        |

### Features

- Anodized aluminium housing
- Dimensions: 431x44x44 mm (Width x Height x Depth) (without mounting supports)
- Panels adjusted to 1U 19" mounting
- Panels can be mounted vertically
- Equipped with M6 rack bolts
- Socket with pin have protection against accidental placement of other items
- H05W-F-3G 1.5 mm supply cable, width: 3 m
- IP20 protection
- In accordance with CE Standards
- Tailor-made construction

## Ordering options

| Sockets qnt |                   | Connector/socket type |           |          | Distribution unit type |   |
|-------------|-------------------|-----------------------|-----------|----------|------------------------|---|
| Qty         | Mounting          | Number                | Connector | Socket   | Number                 | Equipment                                 |
| 5-9         | in 19" housing    | B                     | UNISCHUKO | with pin | B                      | No extra equipment                        |
| A - 10 sck. | Vertical mounting | S                     | UNISCHUKO | Schuko   | L                      | LED switcher                              |
| B - 11 sck. |                   | C                     | UNISCHUKO | C13      | P                      | Surge protection                          |
| C - 12 sck. |                   | D                     | UNISCHUKO | C19      | F                      | Interference eliminator                   |
|             |                   | A                     | C14       | with pin | A                      | Surge protection + Int.el.                |
|             |                   | E                     | C14       | Schuko   | C                      | LED switcher + Surge protection + Int.el. |
|             |                   | F                     | C14       | C13      | D                      | LED switcher + Surge protection           |
|             |                   | G                     | C14       | C19      | E                      | LED switcher + Int.el.                    |

PDU - 8AL



### Optional accessories

- Two-positional LED illuminated switcher
- Extra set of handles to facilitate vertical mounting on an outer part of housing
- Tailored made sockets options
- Adjusted length of a supply cable and a connector
- Ammeter - power meter

### Surge protection

- Reaction time <25 ns
- Absorption of surge energy: 303 J (impulse 10/1000 ns)
- Nominal impulse of power: 7 kA
- Maximum power impulse 10 kA(udar 8/20 ns)

### Interference eliminator

| Max. electrical load |      |    |     |    |    |
|----------------------|------|----|-----|----|----|
| f [MHz]              | 0.15 | 1  | 4.7 | 10 | 30 |
| symmetrical mode     |      |    |     |    |    |
| A [dB]               | 29   | 42 | 30  | 47 | 43 |
| assymetrical mode    |      |    |     |    |    |
| A [dB]               | 25   | 62 | 64  | 43 | 22 |





# LOGIWIRE

## LOGIWIRE

Tailor-made teleinformatic mini-unit inside



### EASY TO INSTALL

WM and FM versions



### MODULAR CONSTRUCTION

Tailor made residential cabling solution



### MODULAR DIMENSIONS

available in 4 variants



### STANDARD AND PREMIUM LINE

Solution for all demands

your apartment



**ANALOGUE/DIGITAL  
VOICE MODULE**

Tailor made residential  
cabling solution



**DATA MODULE**

DATA cable termination  
on modules in accordance  
with 5e or 6 cat.



**SIGNAL INTEGRATION**

Multimedia box facilitates  
**one-solid cabling topology**

FO MEDIA  
COPPER COAX



**COMPLIANCE**

Full compliance with necessary  
norms and regulations

# LogiWire Distribution Box flush mount option



### Description

→ FIBRAIN LogiWIRE system is a demarcation point between external and internal telecommunication installations. It is dedicated for residential and small office areas. Distribution boxes are the key element of whole LogiWIRE system.

### Features

- Flush mounted version
- Frame and door made of plastic (white)
- Effective WiFi transmission
- Perforated mounting plate for easy installation
- Dedicated areas for different types of inserts
- Right or left hand door

### Assembly set

- Plastic frame
- Door made of plastic (white or transparent)
- FO termination outlet VFTO-E1
- 2x FO S.C/APC Simplex adapter
- Adapter for 2x keystone connection module, 2x F2F
- 2x keystone, unshielded Cat5 connection modules
- Power supply socket 1x230V

### Technical specification

| Dimensions [mm] |        |       |               |
|-----------------|--------|-------|---------------|
| Width           | Height | Depth | Option        |
| 370             | 270    | 115   | Flush mounted |

### Ordering information

| Code         | Description  |
|--------------|--|
| FLW-ECO-FM-W | LogiWire Distribution Box, flush mounted, ECO line |

### Additional accessories

| Code         | Description                                       |
|--------------|---|
| FLW-APKF-M3  | Adapter for 2x keystone connection module, 2x F2F |
| FLW-PU-M1    | Power supply socket 1x230V                        |
| VFTO-E1-BL-0 | FO termination outlet VFTO-E1                     |

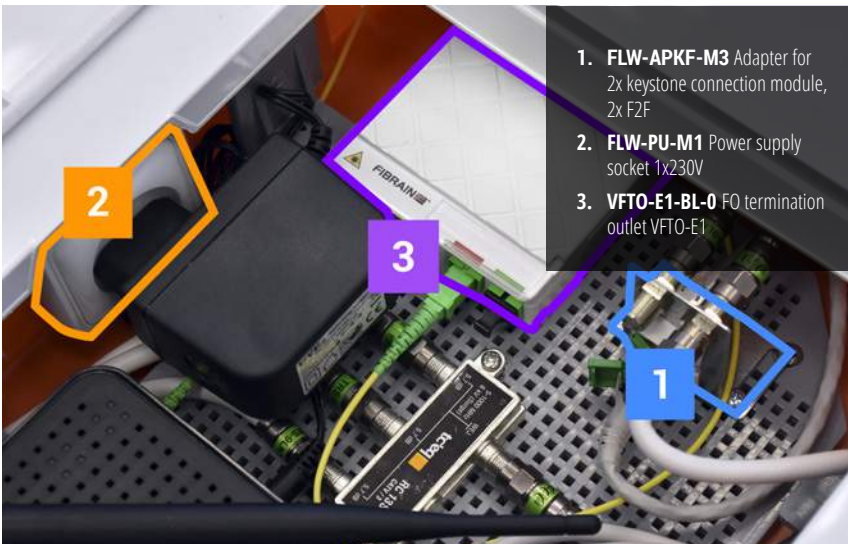

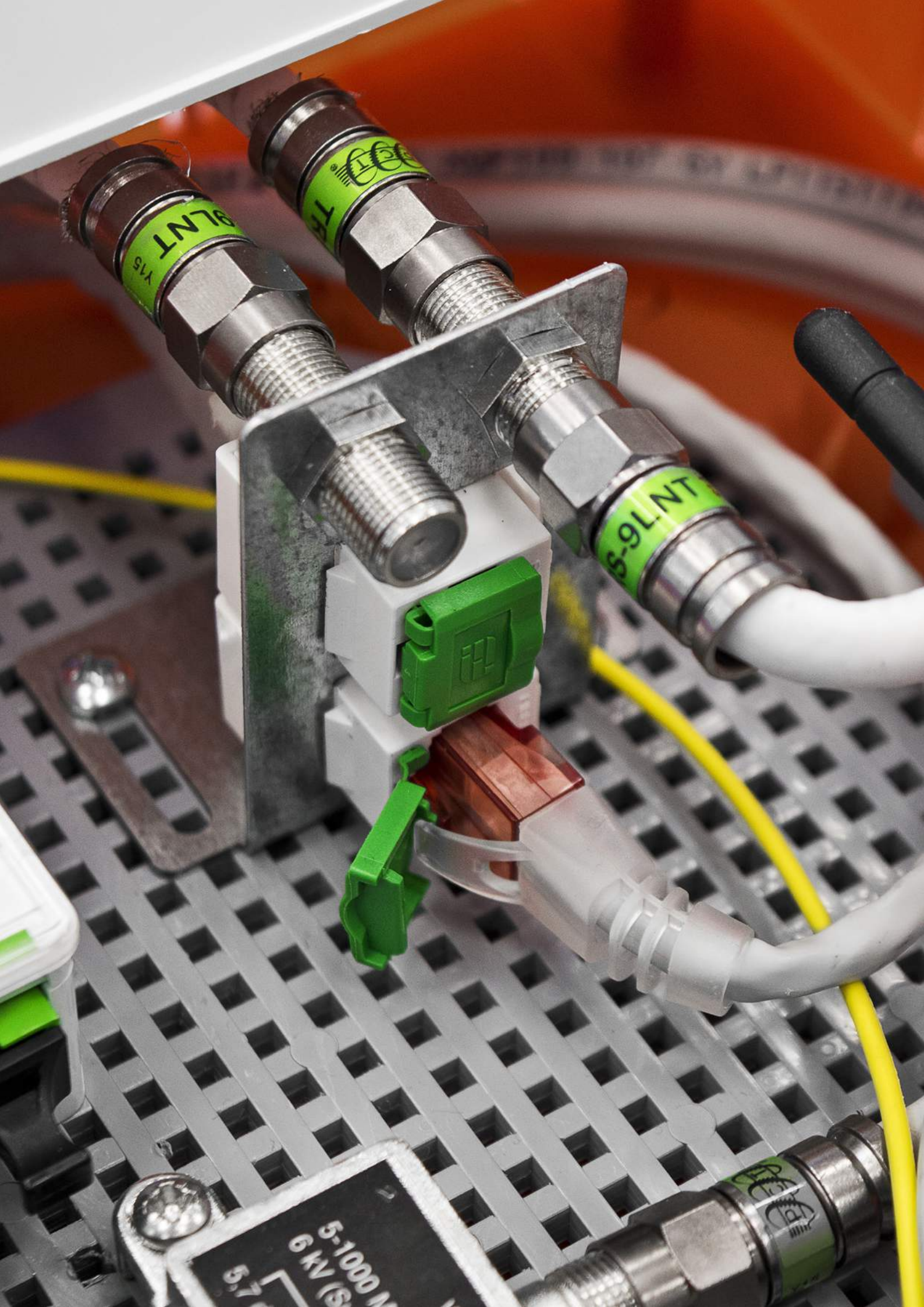

# Mounting boxes - wall mount option

## MINI Wall mount box FLW-10N-WM

| Dimensions [mm]    |         |                   |     |
|--------------------|---------|-------------------|-----|
| Length             | Height  | Depth             | Rim |
| 370                | 270     | 115               | -   |
| Cable entries [mm] |         |                   |     |
| Left/right         | Up/down | Back              |     |
| -                  | -       | 4x $\Phi$ 50 pass |     |



### Features

- Media and devices integration (TEL, Audio, TV, ALARM, INTERCOM, CCTV, DATA)
- Material: powder-coated steel sheet
- Simple mounting (a lot of cable entries)
- Equipped with a lock
- Boxes in other dimensions available
- Left or right mounting
- Horizontal or vertical module mounting
- Compliance with TIA 570-B standard

## MIDI Wall mount box FLW-14N-WM

| Dimensions [mm]    |         |                   |     |
|--------------------|---------|-------------------|-----|
| Length             | Height  | Depth             | Rim |
| 370                | 370     | 115               | -   |
| Cable entries [mm] |         |                   |     |
| Left/right         | Up/down | Back              |     |
| -                  | -       | 4x $\Phi$ 50 pass |     |



## MAXI Wall mount box FLW-28N-WM

| Dimensions [mm]    |         |                   |     |
|--------------------|---------|-------------------|-----|
| Length             | Height  | Depth             | Rim |
| 370                | 720     | 115               | -   |
| Cable entries [mm] |         |                   |     |
| Left/right         | Up/down | Back              |     |
| -                  | -       | 8x $\Phi$ 50 pass |     |



## MAXI-LONG Wall mount box FLW-48N-WM

| Dimensions [mm]    |         |                    |     |
|--------------------|---------|--------------------|-----|
| Length             | Height  | Depth              | Rim |
| 370                | 1220    | 115                | -   |
| Cable entries [mm] |         |                    |     |
| Left/right         | Up/down | Back               |     |
| -                  | -       | 14x $\Phi$ 50 pass |     |





**Flush mount box MINI**  
FLW-10N-EH

| Dimensions [mm]       |                       |                   |         |
|-----------------------|-----------------------|-------------------|---------|
| Length                | Height                | Depth             | Rim     |
| 370                   | 270                   | 100               | 434x324 |
| Cable entries [mm]    |                       |                   |         |
| Left/right            | Up/down               | Back              |         |
| 1x $\Phi$ 50 knockout | 4x $\Phi$ 50 knockout | 4x $\Phi$ 50 pass |         |



**Features**

- Media and devices integration (TEL, Audio, TV, ALARM, INTERCOM, CCTV, DATA)
- Material: powder-coated steel sheet
- Simple mounting (a lot of cable entries)
- Equipped with a lock
- Boxes in other dimensions available
- Left or right mounting
- Horizontal or vertical module mounting
- Compliance with TIA 570-B standard

**Flush mount box MIDI**  
FLW-14N-EH

| Dimensions [mm]       |                       |                   |         |
|-----------------------|-----------------------|-------------------|---------|
| Length                | Height                | Depth             | Rim     |
| 370                   | 370                   | 100               | 434x424 |
| Cable entries [mm]    |                       |                   |         |
| Left/right            | Up/down               | Back              |         |
| 1x $\Phi$ 50 knockout | 4x $\Phi$ 50 knockout | 4x $\Phi$ 50 pass |         |



**Flush mount box MAXI**  
FLW-28N-EH

| Dimensions [mm]       |                       |                   |         |
|-----------------------|-----------------------|-------------------|---------|
| Length                | Height                | Depth             | Rim     |
| 370                   | 720                   | 100               | 434x774 |
| Cable entries [mm]    |                       |                   |         |
| Left/right            | Up/down               | Back              |         |
| 2x $\Phi$ 50 knockout | 4x $\Phi$ 50 knockout | 8x $\Phi$ 50 pass |         |



**Flush mount box MAXI-LONG**  
FLW-48N-EH

| Dimensions [mm]       |                       |                    |          |
|-----------------------|-----------------------|--------------------|----------|
| Length                | Height                | Depth              | Rim      |
| 370                   | 1220                  | 100                | 434x1274 |
| Cable entries [mm]    |                       |                    |          |
| Left/right            | Up/down               | Back               |          |
| 3x $\Phi$ 50 knockout | 4x $\Phi$ 50 knockout | 14x $\Phi$ 50 pass |          |



## Mounting modules - data

LogiWIRE

### 8xRJ45 UTP Cat.5e module FLW-DM5-U8

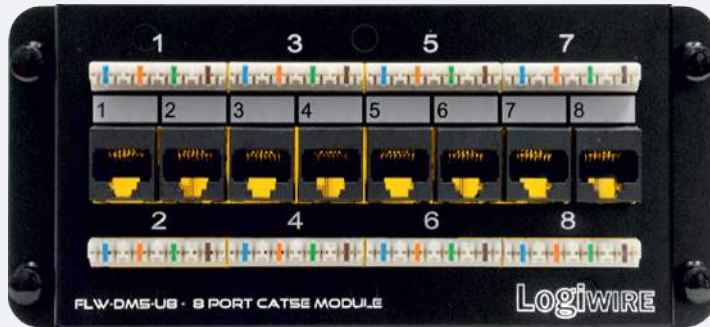

#### Features

- 8-pin IDC connector, 8 ports RJ45 Cat.5e
- Powder painted RAL 9005
- Cable form scheme: T568A/B

#### Parameters

- RJ45 Cat.5e socket
- Socket durability > 750 connection cycles
- Contacts of 0.46 mm diameter covered with gold layer
- IDC connectors accept 22-26 AWG wire
- Cable form scheme: T568A and T568B

#### Standards

- Permanent Link/Channel in accordance with TIA/EIA 568B-2.1
- ISO/IEC 11801
- CENELEC EN 50173
- IEC 60603-7

### 8xRJ45 UTP Cat.6 module FLW-DM6-U8

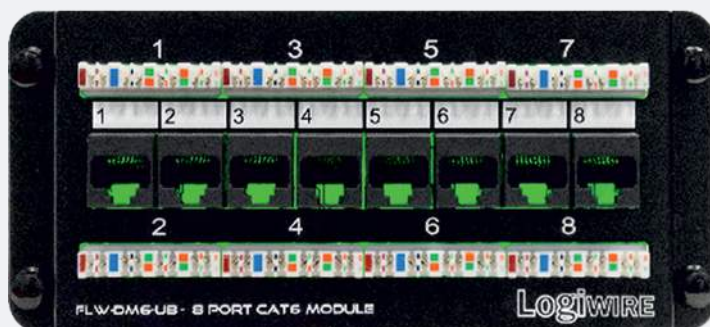

#### Features

- 8-pin IDC connector
- 8 ports RJ45 Cat.6
- Powder painted RAL 9005
- Cable form scheme: T568A/B

#### Parameters

- RJ45 Cat.6 socket
- Socket durability > 750 connection cycles
- Contacts of 0.46 mm diameter covered with gold layer
- IDC connectors accept 22-26 AWG wire
- Cable form scheme: T568A and T568B

#### Standards

- Permanent Link/Channel in accordance with TIA/EIA 568B-2.1
- ISO/IEC 11801
- CENELEC EN 50173
- IEC 60603-7

# Mounting modules - voice

Premium line

## RJ45, 8pins IDC, 8x8pins IDC module FLW-OPT-I8

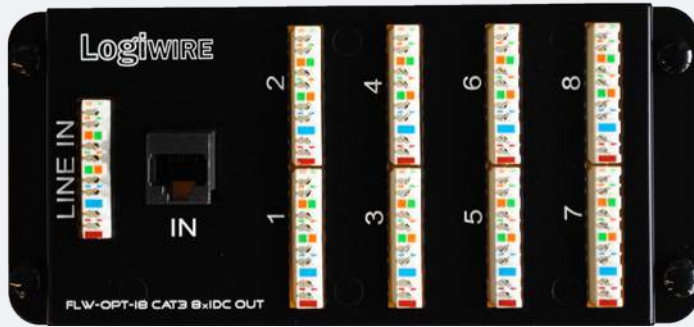

### Features

- 8-pin IDC connector, RJ-45 input
- 8x8pins IDC output
- Powder painted RAL 9005
- Cable form scheme: T568A/B
- Up to 4 telephone lines support on port

### Parameters

- IDC/RJ45 socket
- Socket durability> 750 connection cycles
- IDC connectors accept 22-26 AWG wire
- Cable form scheme: T568A and T568B

## RJ45, 8pins IDC, 8xRJ45 module FLW-OPT-R8

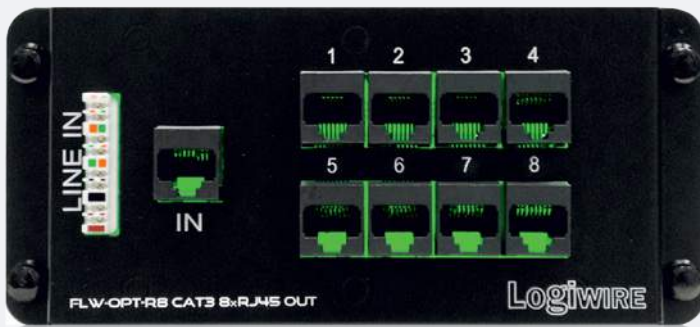

### Features

- 8-pin IDC connector, RJ-45 input
- 8x8pins IDC output
- Powder painted RAL 9005
- Cable form scheme: T568A/B
- Up to 4 telephone lines support on port

### Parameters

- IDC/RJ45 socket
- Socket durability> 750 connection cycles
- IDC connectors accept 22-26 AWG wire
- Cable form scheme: T568A and T568B

# Mounting modules - accessories

## Mounting module FLW-BMP-M1

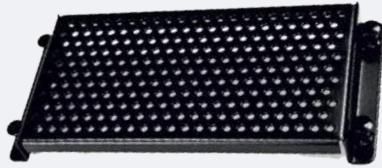

### Features

- Enables installation any teleinformatic component
- Facilitates development of LogiWire solutions
- Equipped with installation sieve (openings: 2.8 mm)

## Support panel FLW-ABP-M1



### Features

- Enables installation of extra panels and adapters
- Facilitates development of LogiWire solutions for "keystone" modules, F-connector
- Adapted to mount 2 panels of adapters

## Adapters



**6x keystone panel**  
FLW-APK-M6

**4x keystone panel**  
FLW-APK-M4

**6x F-connector panel**  
FLW-APFF-M4

### Features

- Facilitates mounting "keystone" adapters
- Design to construct indirect connection for transmission media
- 4 or 6 openings to mount "keystone" adapters
- 6 openings to mount FtoF

## Masking panels with holes FLW-BMP-T2



### Features

- Cover extra cables inside mounting box
- Protect cables against damage
- Height of cable entry: 30 mm
- 2 cable entries
- Mounting openings for masking frames

## Power distribution units PDU-2BB



### Features

- 2x socket with pin
- Cable terminated with power unit
- Max. electrical load 16 A

### 1 GPON Modules

It is a passive fiber optic network in which signal is sent to particular users with the use of single-mode optical fiber separated by splitters.

### 2 Phone modules

Phone panel multiplies the entering signals. There is a possibility of termination 4 entering lines out of 8 RJ45ports or IDC connection.

### 3 DATA Modules

DATA modules (cat. 5e, 6) are used for termination installation cables inside the buildings. They function as a patch panel in a minimized form, which is designed for housing market.

### 4 Fiber optic modules

By using termination elements from Fibrain fiber optic systems- the system is ready for implementation complete solution from the transmitting station.

### 5 Connecting elements

Specially selected short sections of patch panel cables enable proper arrangement of cables. 2 levels of termination facilitates separating cables.

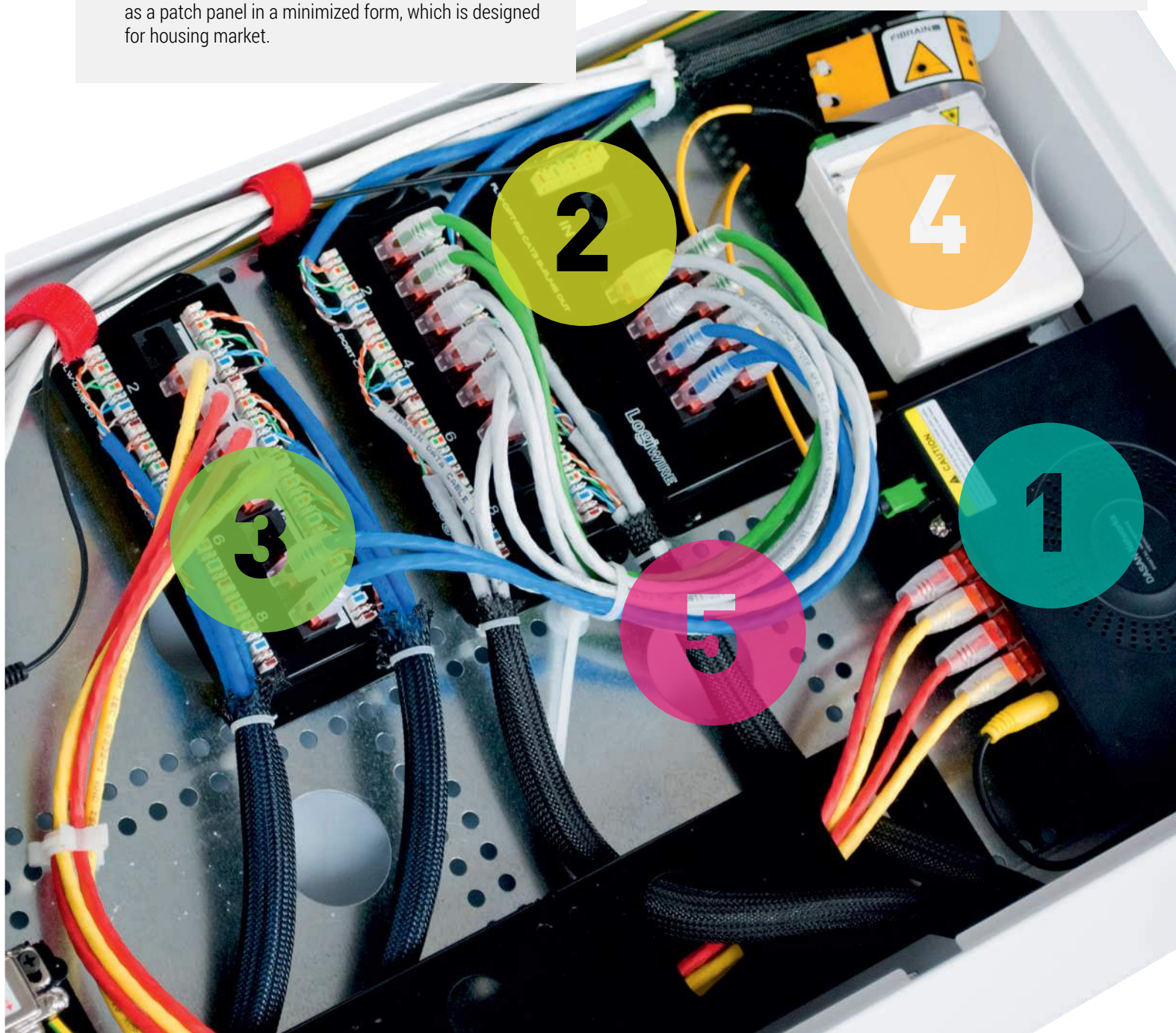

**FIBER  
OPTIC**



**FIBRAINDATA**

# INSTALLATION CABLES

Fiber optics installation cables for today's



**MM FIBERS**  
OM1-OM4 categories



**SM FIBERS**  
OS1/OS2 categories



**INDOOR  
AND OUTDOOR  
APPLICATIONS**  
Variety of external  
jackets LSOH/HDPE

# INSTALLATION CABLES

and future application



## READY FOR HARSH ENVIRONMENT

Rodent and mechanical protection



## EASY TO TERMINATE

Special construction friendly for the installers



## TRUE COLORS

Color coding for fibers, tubes and jackets



## BENDSAFE

Perfect cables for space restricted areas

# Duplex ZIP cables

## DATACOM

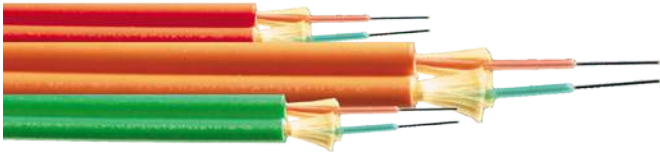

LS0H



Bendsafe



Easy to terminate



Easy-strip



Semi-tight



### Cable structure

1. LS0H outer jacket
2. Aramid yarns
3. Central tight buffer Tube 600/900 µm with colored fibers 250 µm

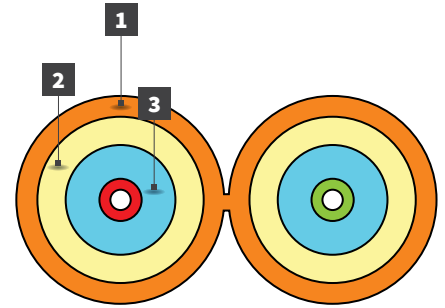

### CONSTRUCTION

| Version | Fiber qty | Dimensions nominal ± 5% [mm] | Max. installation tension (ε=0.5 %) [N] | Crush [N/10 cm] |
|---------|-----------|------------------------------|---|-----------------|
| 2F      | 2         | 1.6 x 3.3                    | 200                                     | 500             |
| 2F      | 2         | 1.8 x 3.7                    | 300                                     | 500             |
| 2F      | 2         | 2.0 x 4.1                    | 400                                     | 500             |
| 2F      | 2         | 2.8 x 5.7                    | 600                                     | 1000            |

### STANDARD JACKET COLOURS

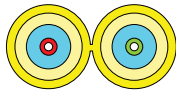

SM G.652D  
Yellow RAL 1021

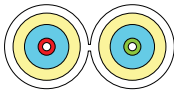

SM G.657  
A1 / A2 / A3  
White RAL 9010

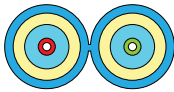

MM 62,5/125 OM1  
Blue RAL 5015

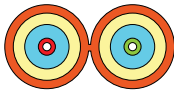

MM 50/125 OM2  
Orange RAL 2003

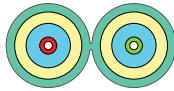

MM 50/125 OM3  
Aqua RAL 6027

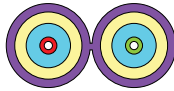

MM 50/125 OM4  
Violet RAL 4003

### Applications

- Distribution systems cable
- Patchcords and pigtails
- Terminals connection

### Construction

- LS0H with low coefficient of friction
- Aramid yarns
- 250 µm coloured fibers

### TEMPERATURE CHARACTERISTICS

|                            |            |
|----------------------------|------------|
| Storage Temperature [°C]   | -40 to +70 |
| Operating Temperature [°C] | -10 to +70 |
| During installation [°C]   | -5 to +55  |

### SM low-radius bending resistance

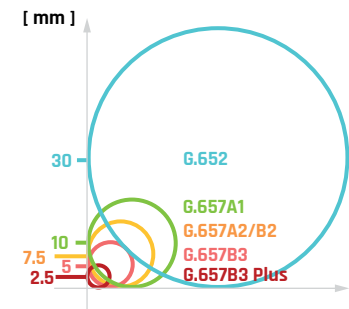



# LDC cables

## DATACOM



### Cable structure

1. Outer jacket LSOH UV stabilized
2. Tight tubes 900 µm (LSOH) with colored fibers 250 µm
3. Aramid yarns

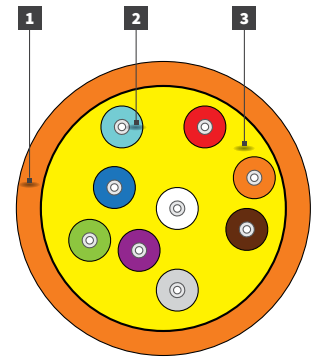

LSOH



Bendsafe



Easy to terminate



Easy-strip



Semi-tight



Datacenter



TRUE COLORS

| CONSTRUCTION |                     |             |                                  |                       |           |                 |
|--------------|---------------------|-------------|----------------------------------|-----------------------|-----------|-----------------|
| Version      | Tight buffers [pcs] | Ø ± 5% [mm] | Nominal weight LSOH ± 5% [kg/km] | Max. tensile load [N] |           | Crush [N/10 cm] |
|              |                     |             |                                  | installation          | operation |                 |
| 2F           | 2                   | 4.5         | 21                               | 500                   | 125       | 500             |
| 4F           | 4                   | 5.0         | 26                               |                       |           |                 |
| 6F           | 6                   | 5.5         | 30                               |                       |           |                 |
| 8F           | 8                   | 5.5         | 35                               |                       |           |                 |
| 10F          | 10                  | 6.5         | 40                               | 700                   | 175       | 500             |
| 12F          | 12                  | 6.5         | 45                               |                       |           |                 |
| 16F          | 16                  | 7.0         | 50                               |                       |           |                 |
| 24F          | 24                  | 8.0         | 65                               | 1000                  | 250       |                 |

- ### Applications
- Indoor/outdoor installations
  - Distribution networks in multifamily buildings
  - FTTH Connections
  - Distribution systems
  - Fully dielectric
  - LAN and FTTH network
  - ODF connection
  - Datacenter distribution

| STANDARD JACKET COLOURS  |     |       |      |        |       |      |       |        |       |            |        |      |
|--|-----|-------|------|--------|-------|------|-------|--------|-------|------------|--------|------|
| D-DATACOM (ACCORDING TO DIN VDE 0888 & IEC 60304) - Fibers & Buffers |     |       |      |        |       |      |       |        |       |            |        |      |
| 1-12   | 1   | 2     | 3    | 4      | 5     | 6    | 7     | 8      | 9     | 10         | 11     | 12   |
| Fiber  | Red | Green | Blue | Yellow | White | Grey | Brown | Violet | Aqua  | Black      | Orange | Pink |
| Buffer   | Red | Green | Blue | Yellow | White | Grey | Brown | Violet | Aqua  | Black      | Orange | Pink |
| Colour<br>250/600/900 µm   | red | green | blue | yellow | white | grey | brown | violet | aqua  | black      | orange | pink |
| 13-24  | 13  | 14    | 15   | 16     | 17    | 18   | 19    | 20     | 21    | 22         | 23     | 24   |
| Fiber  | Red | Green | Blue | Yellow | White | Grey | Brown | Violet | Aqua  | Natural    | Orange | Pink |
| Code   | Red | Green | Blue | Yellow | White | Grey | Brown | Violet | Aqua  | Natural    | Orange | Pink |
| Colour<br>250 µm   | red | green | blue | yellow | white | grey | brown | violet | aqua  | natural    | orange | pink |
| Colour*<br>600/900 µm  | red | green | blue | yellow | white | grey | brown | violet | brown | dark green | orange | pink |

- ### Construction
- Compact design
  - Lightweight
  - Flexible
  - Easy to strip
  - Fully dielectric
  - Reduced diameter
  - Direct connectorization

| TEMPERATURE CHARACTERISTICS |            |
|-----------------------------|------------|
| Storage Temperature [°C]    | -40 to +70 |
| Operating Temperature [°C]  | -10 to +70 |
| During installation [°C]    | -5 to +55  |

\*Buffer with black mark to identify fibers 13-24

# LBR cables

## DATACOM



### Cable structure

1. Outer jacket LSOH UV stabilized
2. Subcables 1.8 mm with tight tubes 900 μm (LSOH) with 250 μm colored fibers
3. Aramid yarns
4. Central FRP strength member
5. Ripcord

## Fiber Optic Solutions

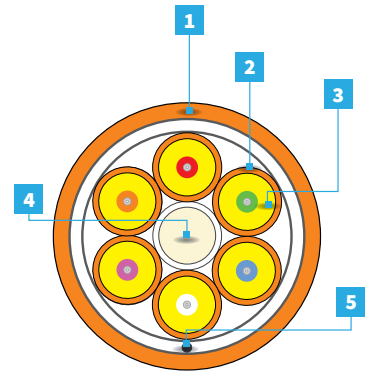

LSOH



Bendsafe



Easy to terminate



Easy-strip



Semi-tight



Datacenter



TRUE COLORS

### CONSTRUCTION

| Version | Fiber qty | Dimensions nominal ± 5% [mm] | Max. installation tension (ε=0.5 %) [N] | Crush [N/10 cm] |
|---------|-----------|------------------------------|---|-----------------|
| 2F      | 2         | 1.6 x 3.3                    | 200                                     | 500             |
| 2F      | 2         | 1.8 x 3.7                    | 300                                     | 500             |
| 2F      | 2         | 2.0 x 4.1                    | 400                                     | 500             |
| 2F      | 2         | 2.8 x 5.7                    | 600                                     | 1000            |

### STANDARD JACKET COLOURS



PE Black RAL9005

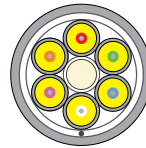

LSOH Grey RAL7022

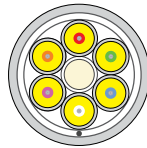

LSOH Light Grey RAL7037

### OUTER JACKET COLOUR OPTIONS

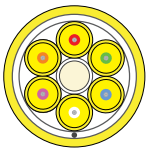

SM G.652D RAL 1021

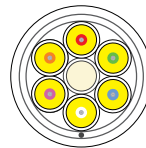

SM G657A1, A2, A3 RAL 9010

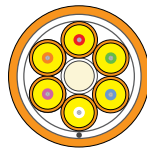

MM 50/125 OM2 RAL 2003

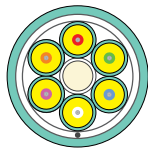

MM 50/125 OM3 RAL6027

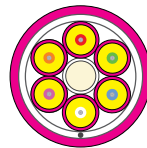

MM 50/125 OM4 RAL4003

### Applications

- Indoor/outdoor installations
- Distribution networks in multifamily buildings
- FTTH Connections
- Distribution systems
- Fully dielectric
- LAN and FTTH network
- ODF connection
- Datacenter distribution

### Construction

- Simplex sub cable up to 24 fibers
- Fully dielectric cable
- Aramid yarns as tensile elements
- UV Resistant and LSOH flame retardant outer jacket

### TEMPERATURE CHARACTERISTICS

|                            |            |
|----------------------------|------------|
| Storage Temperature [°C]   | -40 to +70 |
| Operating Temperature [°C] | -20 to +70 |
| During installation [°C]   | -5 to +55  |

# DC-PRIM cables

## DATACOM



LS0H



Bendsafe



Easy to terminate



Datacenter



### Cable structure

1. LS0H outer jacket
2. Aramid yarns
3. 250 µm optical fibers

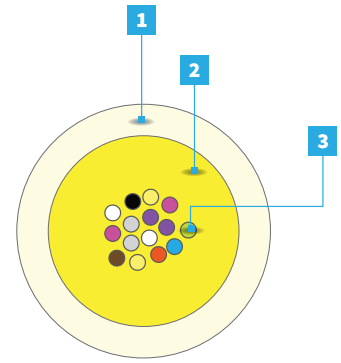

## Fiber Optic Installation Cables

### CONSTRUCTION

| No. of fibers                 | 12                         | 24                         |
|-------------------------------|----------------------------|----------------------------|
| Outer diameter [mm] (±5%)     | 3.0                        | 3.5                        |
| Max tensile load (ε=0.5%) [N] | 350                        | 350                        |
| Weight [kg/km] (±10%)         | 8                          | 9                          |
| Crush [N/10 cm]               | 350                        |                            |
| Min. bend radius [mm]         | 45 (depends on fiber type) | 60 (depends on fiber type) |

### Applications

- Optical cable with aramid yarns reinforcement
- Customer connection, fully dielectric cable
- MTP/MPO termination cable
- LAN and FTTX networks
- Distribution network
- Inside house OLT connection
- Data Center connections cable

### OUTER JACKET COLOUR OPTIONS

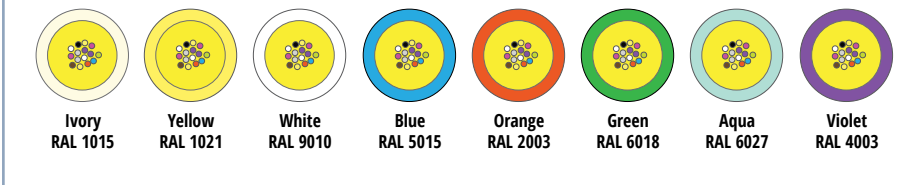

### Construction

- Aramid strength element
- 250 µm optical fibers (12-24)
- LS0H outer jacket

### AVAILABLE FIBER COLOURS

D-DATACOM (ACCORDING TO DIN VDE 0888 & IEC 60304)

|         | 1-12  | 1   | 2     | 3    | 4      | 5     | 6    | 7     | 8      | 9     | 10         | 11     | 12   |
|---------|-------|-----|-------|------|--------|-------|------|-------|--------|-------|------------|--------|------|
| Fiber   |       | ■   | ■     | ■    | ■      | ■     | ■    | ■     | ■      | ■     | ■          | ■      | ■    |
| Colour  |       | red | green | blue | yellow | white | grey | brown | violet | aqua  | black      | orange | pink |
|         | 13-24 | 13  | 14    | 15   | 16     | 17    | 18   | 19    | 20     | 21    | 22         | 23     | 24   |
| Fiber   |       | ■   | ■     | ■    | ■      | ■     | ■    | ■     | ■      | ■     | ■          | ■      | ■    |
| Code    |       | ■ ■ | ■ ■   | ■ ■  | ■ ■    | ■ ■   | ■ ■  | ■ ■   | ■ ■    | ■ ■   | ■ ■        | ■ ■    | ■ ■  |
| Colour* |       | red | green | blue | yellow | white | grey | brown | violet | brown | dark green | orange | pink |

### TEMPERATURE CHARACTERISTICS

|                            |            |
|----------------------------|------------|
| Storage Temperature [°C]   | -40 to +70 |
| Operating Temperature [°C] | -10 to +70 |
| During installation [°C]   | -5 to +55  |

\*Fiber with black mark to identify fibers 13-24

# EXO-GU cables

## DATACOM

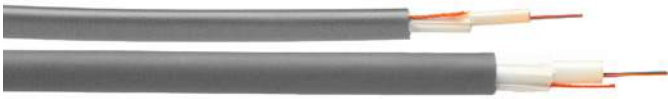

### Cable structure

1. LSOH outer jacket
2. Central loose tube (PBT) with colored fibers in filling compound
3. Optical fibers
4. Fiberglass yarns
5. Ripcord



Datacom



Compact design



LSOH



Basic Rodent Protection

### CONSTRUCTION

| Version  | Fiber qty | Fibers per tube | Ø ± 5% [mm] | Nominal weight LSOH ± 5% [kg/km] | Max. tensile load [N] |           | Crush [N/10 cm] |
|----------|-----------|-----------------|-------------|----------------------------------|-----------------------|-----------|-----------------|
|          |           |                 |             |                                  | installation          | operation |                 |
| 1T x 2F  | 2         | 2               | 5.8         | 34                               | 1200<br>(ε=0,33%)     | 400       | 1500            |
| 1T x 4F  | 4         | 4               | 5.8         | 34                               |                       |           |                 |
| 1T x 6F  | 6         | 6               | 5.8         | 35                               |                       |           |                 |
| 1T x 8F  | 8         | 8               | 5.8         | 35                               |                       |           |                 |
| 1T x 12F | 12        | 12              | 5.8         | 35                               |                       |           |                 |
| 1T x 16F | 16        | 16              | 5.8         | 35                               |                       |           |                 |
| 1T x 18F | 18        | 18              | 5.8         | 36                               |                       |           |                 |
| 1T x 24F | 24        | 24              | 5.8         | 36                               |                       |           |                 |

### Applications

- Fully dielectric cable
- Basic rodent protection
- LAN and FTTX networks
- Distribution network
- ODF connections

### Construction

- Central Loose tube (PBT) with filling compound
- Optical fibers
- Fiberglass as water absorbent and strain relief element
- LSOH outer jacket

### AVAILABLE FIBER COLOURS

D-DATACOM (ACCORDING TO DIN VDE 0888 & IEC 60304) - Fibers

| 1-12   | 1   | 2     | 3    | 4      | 5     | 6    | 7     | 8      | 9    | 10         | 11     | 12   |
|--------|-----|-------|------|--------|-------|------|-------|--------|------|------------|--------|------|
| Code   |     |       |      |        |       |      |       |        |      |            |        |      |
| Colour | red | green | blue | yellow | white | grey | brown | violet | aqua | black      | orange | pink |
| 13-24  | 13  | 14    | 15   | 16     | 17    | 18   | 19    | 20     | 21   | 22         | 23     | 24   |
| Code   |     |       |      |        |       |      |       |        |      |            |        |      |
| Colour | red | green | blue | yellow | white | grey | brown | violet | aqua | dark green | orange | pink |

### TEMPERATURE CHARACTERISTICS

|                            |            |
|----------------------------|------------|
| Storage Temperature [°C]   | -20 to +70 |
| Operating Temperature [°C] | -20 to +70 |
| During installation [°C]   | -5 to +55  |

\*In 24-fiber tube construction colours will be repeated to facilitate identification, fibers 13-24 will have rings every 25 cm;

### Jacket colours

Standard



PE Black RAL 9005



LSOH Grey RAL 7022

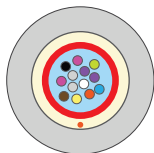

LSOH Light Grey RAL 7037

### Fiber identification

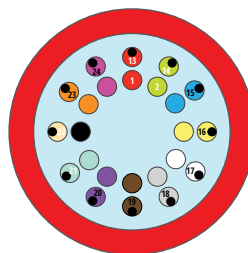

Optional



SM G.652D RAL 1021

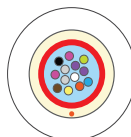

SM G657 A1, A2, A3 RAL 9010

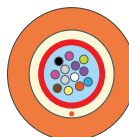

MM 50/1025 OM2 RAL 2003

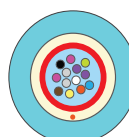

MM 50/1025 OM3 RAL 6027



MM 50/1025 OM4 RAL 4003

# BDC-MSA cables

## DATACOM



### Cable structure

1. LSOH outer jacket
2. Water-blocking fiberglass yarns
3. Water blocking yarns
4. PET tape
5. Central strength member (FRP)
6. Loose tubes (PBT) with colored fibers in filling gel
7. Fillers
8. Ripcord

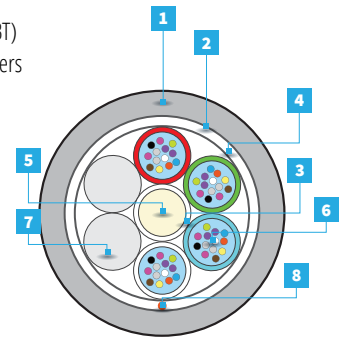





Datacom



ETR



Compact design



LSOH



Basic Rodent Protection



Datacenter

| CONSTRUCTION |        |                 |                |              |             |                               |                                 |                       |            |                 |
|--------------|--------|-----------------|----------------|--------------|-------------|-------------------------------|---------------------------------|-----------------------|------------|-----------------|
| Version      | Fibers | Fibers per tube | Total elements | Active tubes | Ø ± 5% [mm] | Nominal weight PE ±5% [kg/km] | Nominal weight LSOH ±5% [kg/km] | Max. tensile load [N] |            | Crush [N/10 cm] |
|              |        |                 |                |              |             |                               |                                 | instal-lation         | oper-ation |                 |
| 1T x 12F     | 12     | 12              | 6              | 1            | 8.2         | 50                            | 65                              | 1500                  | 550        | 1500            |
| 2T x 6F      | 12     | 6               | 6              | 2            | 8.2         | 50                            | 65                              | 1550                  | 780        |                 |
| 2T x 12F     | 24     | 12              | 6              | 2            | 8.2         | 51                            | 65                              | 1500                  | 550        |                 |
| 4T x 6F      | 24     | 6               | 6              | 4            | 8.2         | 51                            | 66                              | 1550                  | 780        |                 |
| 3T x 12F     | 36     | 12              | 6              | 3            | 8.2         | 52                            | 67                              | 1500                  | 550        |                 |
| 6T x 6F      | 36     | 6               | 6              | 6            | 8.2         | 53                            | 68                              | 1550                  | 780        |                 |
| 4T x 12F     | 48     | 12              | 6              | 4            | 8.2         | 53                            | 68                              | 1500                  | 550        |                 |
| 5T x 12F     | 60     | 12              | 6              | 5            | 8.2         | 54                            | 69                              | 1500                  | 550        |                 |
| 6T x 12F     | 72     | 12              | 6              | 6            | 8.2         | 54                            | 69                              | 1500                  | 550        |                 |
| 8T x 12F     | 96     | 12              | 8              | 8            | 9.3         | 71                            | 86                              | 1620                  | 750        |                 |
| 12T x 12F    | 144    | 12              | 12             | 12           | 11.5        | 104                           | 126                             | 1620                  | 850        |                 |

**Applications**

- Fully dielectric cable
- Basic rodent protection
- LAN and FTX networks
- Distribution network
- ODF connections

**Construction**

- FRP strength and anti-buckling element
- Optical fibers
- Loose tube with filling compound (PBT Ø 1.8 mm)
- Dry yarns to prevent moisture into the cable
- Fiberglass as water absorbent and strain relief element
- UV stabilized LSOH jacket

| AVAILABLE FIBER COLOURS                                    |                                    |                                      |                                     |                                       |                                      |                                     |                                      |                                       |                                     |                                      |                                       |                                     |
|--|------------------------------------|--------------------------------------|-------------------------------------|---------------------------------------|--------------------------------------|-------------------------------------|--------------------------------------|---------------------------------------|-------------------------------------|--------------------------------------|---------------------------------------|-------------------------------------|
| D-DATACOM (ACCORDING TO DIN VDE 0888 & IEC 60304) - Fibers |                                    |                                      |                                     |                                       |                                      |                                     |                                      |                                       |                                     |                                      |                                       |                                     |
| 1-12   | 1                                  | 2                                    | 3                                   | 4                                     | 5                                    | 6                                   | 7                                    | 8                                     | 9                                   | 10                                   | 11                                    | 12                                  |
| Code   | <span style="color: red;">■</span> | <span style="color: green;">■</span> | <span style="color: blue;">■</span> | <span style="color: yellow;">■</span> | <span style="color: white;">■</span> | <span style="color: grey;">■</span> | <span style="color: brown;">■</span> | <span style="color: purple;">■</span> | <span style="color: cyan;">■</span> | <span style="color: black;">■</span> | <span style="color: orange;">■</span> | <span style="color: pink;">■</span> |
| Colour   | red                                | green                                | blue                                | yellow                                | white                                | grey                                | brown                                | violet                                | aqua                                | black                                | orange                                | pink                                |

| TEMPERATURE CHARACTERISTICS |            |
|-----------------------------|------------|
| Storage Temperature [°C]    | -40 to +70 |
| Operating Temperature [°C]  | -20 to +70 |
| During installation [°C]    | -5 to +55  |

| D-DATACOM (ACCORDING TO DIN VDE 0888 & IEC 60304) - Tubes |                                    |                                      |                                     |                                       |                                      |                                     |                                      |                                       |                                     |                                      |                                       |                                     |
|---|------------------------------------|--------------------------------------|-------------------------------------|---------------------------------------|--------------------------------------|-------------------------------------|--------------------------------------|---------------------------------------|-------------------------------------|--------------------------------------|---------------------------------------|-------------------------------------|
| Tube  | 1                                  | 2                                    | 3                                   | 4                                     | 5                                    | 6                                   | 7                                    | 8                                     | 9                                   | 10                                   | 11                                    | 12                                  |
| Code  | <span style="color: red;">■</span> | <span style="color: green;">■</span> | <span style="color: blue;">■</span> | <span style="color: yellow;">■</span> | <span style="color: white;">■</span> | <span style="color: grey;">■</span> | <span style="color: brown;">■</span> | <span style="color: purple;">■</span> | <span style="color: cyan;">■</span> | <span style="color: black;">■</span> | <span style="color: orange;">■</span> | <span style="color: pink;">■</span> |
| Colour  | red                                | green                                | blue                                | yellow                                | white                                | grey                                | brown                                | violet                                | aqua                                | black                                | orange                                | pink                                |

\*In case of lower fiber count some tubes can be replaced by fillers.

# EAC-RAs cables

## FTTH

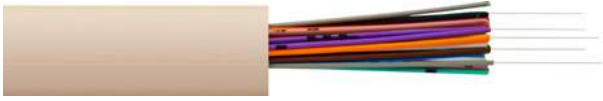

Last mile connection outdoor

LSOH

Flexible

Bendsafe

Easy to terminate

FTTH

### Cable structure

1. LSOH outer jacket
2. Dielectric strength members
3. 900 µm semi tight buffer (LSOH) with colored 250 µm optical fiber

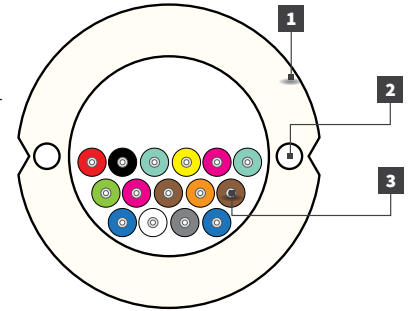

| CONSTRUCTION |        |         |             |                            |                       |                 |
|--------------|--------|---------|-------------|----------------------------|-----------------------|-----------------|
| Version      | Fibers | Buffers | Ø ± 5% [mm] | Nominal weight ±5% [kg/km] | Max. tensile load [N] | Crush [N/10 cm] |
|              |        |         |             |                            | installation          |                 |
| 8F           | 8      | 8       | 8.7         | 68                         | 400                   | 1000            |
| 12F          | 12     | 12      | 8.7         | 72                         | 400                   |                 |
| 16F          | 16     | 16      | 12.0        | 98                         | 600                   |                 |
| 24F          | 24     | 24      | 12.0        | 106                        | 600                   |                 |

**Applications**

- Distribution cable
- For laying in risers
- FTTH feeder
- Easy access and installation

**Construction**

- FRP strength members inside cable jacket
- Optical fibers in bundles
- 2-24 elements in cable
- LSOH UV resistant outer jacket (ivory by default, various colours available)

| AVAILABLE COLOURS                              |   |  |   |  |  |   |  |  |   |                                      |                                     |  |
|--|---|--|---|--|--|---|--|--|---|--------------------------------------|-------------------------------------|--|
| F-FTTH (ACCORDING TO DIN VDE 0888 & IEC 60304) |   |  |   |  |  |   |  |  |   |                                      |                                     |  |
| 1-12   | 1   | 2  | 3   | 4  | 5  | 6   | 7  | 8  | 9   | 10                                   | 11                                  | 12                                     |
| <b>Fiber</b>                                   | <span style="color: red;">■</span>                                      | <span style="color: blue;">■</span>                                      | <span style="color: green;">■</span>                                      | <span style="color: yellow;">■</span>                                      | <span style="color: purple;">■</span>                                      | <span style="color: white;">■</span>                                      | <span style="color: orange;">■</span>                                      | <span style="color: grey;">■</span>                                      | <span style="color: brown;">■</span>                                      | <span style="color: black;">■</span> | <span style="color: cyan;">■</span> | <span style="color: magenta;">■</span> |
| <b>Buffer</b>                                  | <span style="color: red;">■</span>                                      | <span style="color: blue;">■</span>                                      | <span style="color: green;">■</span>                                      | <span style="color: yellow;">■</span>                                      | <span style="color: purple;">■</span>                                      | <span style="color: white;">■</span>                                      | <span style="color: orange;">■</span>                                      | <span style="color: grey;">■</span>                                      | <span style="color: brown;">■</span>                                      | <span style="color: black;">■</span> | <span style="color: cyan;">■</span> | <span style="color: magenta;">■</span> |
| <b>Colour 250 µm</b>                           | red   | blue   | green   | yellow   | violet   | white   | orange   | grey   | brown   | black                                | aqua                                | pink                                   |
| <b>Colour 600/900 µm</b>                       | red   | blue   | green   | yellow   | violet   | white   | orange   | grey   | brown   | black                                | aqua                                | pink                                   |
| 13-24  | 13  | 14   | 15  | 16   | 17   | 18  | 19   | 20   | 21  | 22                                   | 23                                  | 24                                     |
| <b>Fiber</b>                                   | <span style="color: red;">■</span>                                      | <span style="color: blue;">■</span>                                      | <span style="color: green;">■</span>                                      | <span style="color: yellow;">■</span>                                      | <span style="color: purple;">■</span>                                      | <span style="color: white;">■</span>                                      | <span style="color: orange;">■</span>                                      | <span style="color: grey;">■</span>                                      | <span style="color: brown;">■</span>                                      | <span style="color: black;">■</span> | <span style="color: cyan;">■</span> | <span style="color: magenta;">■</span> |
| <b>Code</b>                                    | <span style="color: red;">■</span> <span style="color: black;">■</span> | <span style="color: blue;">■</span> <span style="color: black;">■</span> | <span style="color: green;">■</span> <span style="color: black;">■</span> | <span style="color: yellow;">■</span> <span style="color: black;">■</span> | <span style="color: purple;">■</span> <span style="color: black;">■</span> | <span style="color: white;">■</span> <span style="color: black;">■</span> | <span style="color: orange;">■</span> <span style="color: black;">■</span> | <span style="color: grey;">■</span> <span style="color: black;">■</span> | <span style="color: brown;">■</span> <span style="color: black;">■</span> | <span style="color: green;">■</span> | <span style="color: cyan;">■</span> | <span style="color: magenta;">■</span> |
| <b>Colour 250 µm</b>                           | red   | blue   | green   | yellow   | violet   | white   | orange   | grey   | brown   | black                                | aqua                                | pink                                   |
| <b>Colour* 600/900 µm</b>                      | red   | blue   | green   | yellow   | violet   | white   | orange   | grey   | brown   | dark green                           | aqua                                | pink                                   |

| TEMPERATURE CHARACTERISTICS       |            |
|-----------------------------------|------------|
| <b>Storage Temperature [°C]</b>   | -40 to +70 |
| <b>Operating Temperature [°C]</b> | -20 to +70 |
| <b>During installation [°C]</b>   | -5 to +55  |

\*Buffer with black mark to identify fibers 13-24

# DAC-BURRY cables

FTTH



Direct buried



FTTH



Last mile connection outdoor



Hi-crush



Compact design

### Cable structure

1. PP/HDPE outer jacket
2. Aramid yarns
3. Central loose tube (PBT) with 250 µm colored fibers in filling gel
4. Dielectric strength members in the jacket

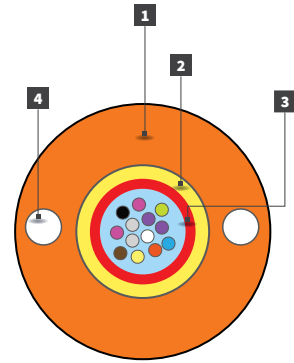

### CONSTRUCTION

| Version  | Fibers | Fibers per tube | Ø ± 5% [mm] | Nominal weight PE ± 5% [kg/km] | Max. tensile load [N] |           | Crush [N/10 cm] |
|----------|--------|-----------------|-------------|--------------------------------|-----------------------|-----------|-----------------|
|          |        |                 |             |                                | installation          | operation |                 |
| 1T x 2F  | 2      | 2               | 6.2         | 32                             | 650                   | 250       | 3500            |
| 1T x 4F  | 4      | 4               | 6.2         | 32                             |                       |           |                 |
| 1Tx 6F   | 6      | 6               | 6.2         | 32                             |                       |           |                 |
| 1T x 8F  | 8      | 8               | 6.2         | 32                             |                       |           |                 |
| 1T x 12F | 12     | 12              | 6.2         | 32                             |                       |           |                 |

### AVAILABLE COLOURS

T-TELECOM (ACCORDING TO IEC 60304) - FIBERS IN TUBE

| 1-12   | 1                                  | 2                                    | 3                                   | 4                                    | 5                                     | 6                                     | 7                                   | 8                                     | 9                                    | 10                                  | 11                                   | 12                                  |
|--------|------------------------------------|--------------------------------------|-------------------------------------|--------------------------------------|---------------------------------------|---------------------------------------|-------------------------------------|---------------------------------------|--------------------------------------|-------------------------------------|--------------------------------------|-------------------------------------|
| Code   | <span style="color: red;">■</span> | <span style="color: green;">■</span> | <span style="color: blue;">■</span> | <span style="color: white;">■</span> | <span style="color: purple;">■</span> | <span style="color: orange;">■</span> | <span style="color: grey;">■</span> | <span style="color: yellow;">■</span> | <span style="color: brown;">■</span> | <span style="color: pink;">■</span> | <span style="color: black;">■</span> | <span style="color: aqua;">■</span> |
| Colour | red                                | green                                | blue                                | white                                | violet                                | orange                                | grey                                | yellow                                | brown                                | pink                                | black                                | aqua                                |

### Applications

- Optical access cable with aramid yarns reinforcement
- Direct buried design
- Fully dielectric cable
- Last mile connection
- High crush resistance (3,5kN)
- Installation into existing ducts or direct buried

### Construction

- Central Loose tube (PBT) with filling compound
- Up to 12 optical fibers (250 µm)
- Aramid yarns as strain relief and water absorbent
- Embedded FRP strength members
- Highly resistant outer jacket made of hard polyolefin material, UV resistant

### TEMPERATURE CHARACTERISTICS

|                            |            |
|----------------------------|------------|
| Storage Temperature [°C]   | -40 to +70 |
| Operating Temperature [°C] | -40 to +70 |
| During installation [°C]   | -15 to +55 |

FIBER  
OPTIC



CONNECTION

# CONNECTION HARDWARE

Full range of connection varieties complying



VARIETY OF FO  
ADAPTERS



ONE-PIECE  
TECHNOLOGY



MM AND SM



STANDARD  
PREMIUM  
PREMIUM SUPER

DIFFERENT  
QUALITY LEVELS

Fulfill all expectations



# HARDWARE

to the customer expectations



**THE HIGHEST  
PERFORMANCE  
AND DURABILITY**



**TRUE  
COLORS**

**TRUE COLORS**  
For efficient color  
coding

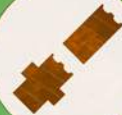

**FLANGE &  
FLANGELESS  
DESIGN**



**SIMPLEX  
& DUPLEX**



**SAFETY FEATURES**  
Laser protection flaps





**FIELD TERMINABLE  
CONNECTORS**

# SC adapters

SC fiber optic adapters are divided into three distinct series: Standard One-Piece, Premium One-Piece and Premium Super One-Piece, which can be characterized by various optical and mechanical parameters. SC fiber optic adapters are constructed in the "one-piece design" technology.

The external housing is one solid body, thus the adapters are more durable than the typical ultrasonic welded type ones. SC fiber optic adapters are available in various options and colours. Optical and mechanical parameters as well as types of adapters are presented in the tables below.

### Technical specifications

| Parameter                              | Standard <i>One-Piece</i>   | Premium <i>One-Piece</i>  | Premium <i>Super One-Piece</i>  |
|--|---|---|---|
| Insertion Loss (IL)                    | max 0.30 dB<br>typ. 0.15 dB   | max 0.20 dB<br>typ. 0.10 dB   | max 0.20 dB<br>typ. 0.08 dB   |
| Repeatability $\Delta$ IL/mating cycle | $\pm 0.10$ dB   | $\pm 0.08$ dB   | $\pm 0.08$ dB   |
| Durability                             | 500 matings/<0.20 dB<br>typical change  | 1000 matings/<0.15 dB<br>typical change   | 1000 matings/<0.15 dB<br>typical change   |
| Strength of coupling mechanism         | 40N   | 80N   | 80N   |
| Operating temperature                  |   | -40 up to +85°C   |   |
| Alignment sleeve                       | ceramic   | ceramic/metal   | ceramic/metal   |
| Mounting                               | metal wings   | metal wings 2D  | plastic wings 4D  |
| External shutter                       | -   | ☑   | -   |
| Internal shutter                       | -   | ☑   | ☑   |
| GR326 TG100 requirements               | -   | ●   | ☑   |
| Anti-fungus plastic                    | -   | -   | ☑   |
| Colours                                |  |  |  |



### Types of adapters in each series

| Parameter             | Standard <i>One-Piece</i> | Premium <i>One-Piece</i> | Premium <i>Super One-Piece</i> |
|-----------------------|---------------------------|--------------------------|--------------------------------|
| SIMPLEX               | ☑                         | ☑                        | ☑                              |
| DUPLEX                | ☑                         | ☑                        | ☑                              |
| FLANGE                | ☑                         | ☑                        | ☑                              |
| NO FLANGE             | ☑                         | ☑                        | ☑                              |
| METAL MOUNTING CLIP   | ☑                         | ☑                        | -                              |
| PLASTIC MOUNTING CLIP | -                         | -                        | ☑                              |
| EXTERNAL SHUTTER      | -                         | ☑                        | -                              |
| INTERNAL SHUTTER      | -                         | ☑                        | ☑                              |

## Standard One-Piece Class

The standard series of SC adapter family is available in a simplex and duplex configuration with a metal mounting clip and an optional flange. The main characteristic of FIBRAIN Standard One-Piece adapters is a ceramic sleeve for a singlemode and multimode application. Adapters are available in 5 colours. Adapters can be fitted with a transparent or semi-transparent dust cup.

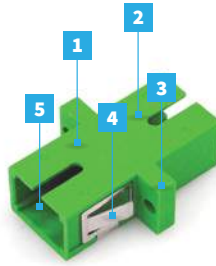

### Adapter construction

1. "One-Piece Design" technology
2. Housing available in 5 colours
3. Flange or flangeless configuration
4. Metal mounting clip
5. Ceramic alignment sleeve for SM and MM application

### Features

- Innovative technology "One-Piece Design" – increased side loading performance
- Equipped with a metal mounting clip
- Possibility to choose a transparent or semi-transparent dust cover
- High quality and durability
- Wide range of colours - 5 colours available

## Premium One-Piece Class

Series of SC fiber optic adapters with improved optical and mechanical performance. The external housing has been reinforced with a metal element, thus adapters exceed the IEC requirements of the strength of coupling mechanism. Adapters are available in a simplex and duplex configuration with an optional flange in 3 colours. The design has proved increased side loading performance over conventional adapters. The Premium One-Piece series can offer adapters with an external or internal shutter.

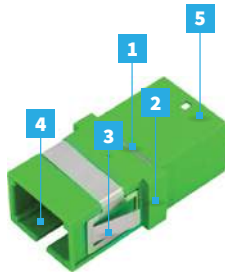

### Adapter construction

1. Metal reinforcing element
2. Flange or flangeless configuration
3. Metal mounting clip
4. Optional shutter (outer or inner)
5. One-Piece solid body

### Features

- Innovative technology "One-Piece Design" – increased side loading performance over conventional adapters
- Available in a simplex or duplex version, in flange or no flange configuration
- External body is strengthened by metal elements – the adapters exceed the IEC 61300-2-6 requirements for strength of coupling mechanism

## Premium Super One-Piece Class

Series of SC adapter family with the highest optical and mechanical parameters. The 'super one-piece design' of housing includes integrated non-metallic panel clips and 4 anti-rattle wings, which significantly reduce movement when snapped into a panel. Adapters are available in a simplex and duplex configuration, in both flange and no flange version.

The Premium Super One-Piece series is constructed from anti-fungus material with the UL94-V0 flammability index.

Adapters are available in 4 colours. There is also version with an inner shutter.

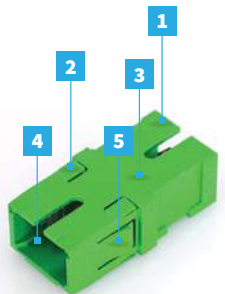

### Adapter construction

1. Anti-fungus plastic
2. Special wings for accurate fixation
3. Super One-Piece solid body
4. Optional shutter (inner)
5. Integrated non-metallic panel clip

### Features

- Innovative technology "Super One-Piece design" provides more durable construction and increased side loading performance
- 4 anti-rattle wings significantly reduce movement when snapped into a panel
- Built-in panel mounting plate
- Constructed from anti-fungus plastic with the UL94-V0 flammability index
- Typical value of Insertion Loss IL<sub>TYP</sub> ≤ 0.08 dB

## ORDERING SYNTAX

| Class   | Connector type | No. of fibers | Shutter type                 | Mounting       | Sleeve                   | Body colour  | Dust cover colour                                    |
|---|----------------|---------------|------------------------------|----------------|--------------------------|--|--|
| <b>A101 (Standard One-Piece)</b>                    |                |               | N/A                          |                | 1 (ceramic)              | 1 (green SM APC)<br>2 (Blue SM PC)<br>5 (Beige MM OM1/2)<br>6 (Aqua MM OM3)<br>7 (Violet MM OM4) | 3 (Black)<br>T (transparent)<br>S (Semi-transparent) |
| <b>A120 (Premium One-Piece)</b>                     | SC (PC)        | SX (Simplex)  | N/A                          | 1 (flange)     |                          | 1 (green SM APC)<br>2 (Blue SM PC)<br>5 (Beige MM OM1/2)   | 3 (Black)  |
| <b>AS20 (Premium One-Piece with shutters)</b>       | SCA (APC)      | DX (Duplex)   | 1 (Internal)<br>2 (External) | 2 (flangeless) | 1 (ceramic)<br>2 (metal) | 1 (green SM APC)<br>2 (Blue SM PC)<br>5 (Beige MM OM1/2)   |  |
| <b>A123 (Premium Super One-Piece)</b>               |                |               | N/A                          |                |                          | 1 (green SM APC)<br>2 (Blue SM PC)<br>5 (Beige MM OM1/2)<br>6 (Aqua MM OM3)                      |  |
| <b>AS23 (Premium Super One-Piece with shutters)</b> |                |               | 1 (Internal)<br>2 (External) |                |                          |  |  |

## Example

A123-SCA-SX-1113 FIBRAIN SC APC SM adapter, SX, Premium Super One-Piece, with flange, ceramic sleeve, green housing, black dust cover

# LC adapters

SC fiber optic adapters are divided into three distinct series: Standard One-Piece, Premium One-Piece and Premium Super One-Piece, which can be characterized by various optical and mechanical parameters. SC fiber optic adapters are constructed in the "one-piece design" technology.

The external housing is one solid body, thus the adapters are more durable than the typical ultrasonic welded type ones. SC fiber optic adapters are available in various options and colours. Optical and mechanical parameters as well as types of adapters are presented in the tables below.

### Technical specifications

| Parameter                             | Standard <i>One-Piece</i>              | Premium <i>One-Piece</i>                | Premium <i>Super One-Piece</i>          |
|---------------------------------------|--|---|---|
| <b>Insertion Loss (IL)</b>            | max 0.30dB<br>typ. 0.15dB              | max 0.20 dB<br>typ. 0.10 dB             | max 0.20 dB<br>typ. 0.08 dB             |
| <b>Repeatability ΔIL/mating cycle</b> | ± 0.10 dB                              | ± 0.08 dB                               | ± 0.08 dB                               |
| <b>Durability</b>                     | 500 matings/<0.20 dB<br>typical change | 1000 matings/<0.15 dB<br>typical change | 1000 matings/<0.15 dB<br>typical change |
| <b>Strength of coupling mechanism</b> | 40N                                    | 80N                                     | 80N                                     |
| <b>Operating temperature</b>          |  | -40 up to +85°C                         |   |
| <b>Alignment sleeve</b>               | ceramic                                | ceramic/metal                           | ceramic/metal                           |
| <b>Mounting</b>                       | metal wings                            | plastic wings 2D                        | plastic wings 4D                        |
| <b>External shutter</b>               | -                                      | ☑                                       | -                                       |
| <b>Internal shutter</b>               | -                                      | ☑                                       | ☑                                       |
| <b>GR326 TG100 requirements</b>       | -                                      | ●                                       | ☑                                       |
| <b>Anti-fungus plastic</b>            | -                                      | -                                       | ☑                                       |
| <b>Colours</b>                        |  |   |   |

### Types of adapters in each series

| Parameter                    | Standard <i>One-Piece</i> | Premium <i>One-Piece</i> | Premium <i>Super One-Piece</i> |
|------------------------------|---------------------------|--------------------------|--------------------------------|
| <b>DUPLEX</b>                | ☑                         | ☑                        | ☑                              |
| <b>QUAD</b>                  | ☑                         | ☑                        | -                              |
| <b>FLANGE</b>                | ☑                         | ☑                        | ☑                              |
| <b>NO FLANGE</b>             | ☑                         | ☑                        | ☑                              |
| <b>METAL MOUNTING CLIP</b>   | ☑                         | -                        | -                              |
| <b>PLASTIC MOUNTING CLIP</b> | -                         | ☑                        | ☑                              |
| <b>EXTERNAL SHUTTER</b>      | -                         | ☑                        | -                              |
| <b>INTERNAL SHUTTER</b>      | -                         | ☑                        | ☑                              |



## Standard One-Piece Class

The basic series of LC adapters in a duplex and quad configuration with an optional flange. A ceramic alignment sleeve, which is used in single-mode and multimode adapters, is a characteristic feature of Standard One-Piece series. Adapters are available in 5 colours with metal mounting clips. Adapters are constructed as one solid body, which provides a more durable design over the typical ultrasonic welded type ones.

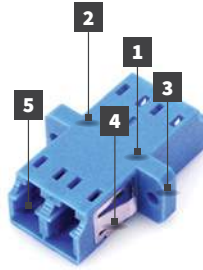

### Adapter construction

1. "One-Piece Design" technology
2. Housing available in 5 colours
3. Optional flange
4. Metal mounting clip
5. Ceramic alignment sleeve for SM and MM application



### Features

- One-Piece Design
- Flange or flangeless configuration
- High quality and durability
- Colour coding according to the standards

## Premium One-Piece Class

Series of LC fiber optic adapters equipped with external or internal shutters, which guarantee protection for the eyes. The adapters are available in a duplex or quad design, with flange or no flange configuration. The Premium One-Piece series has an integrated, non-metallic clips. Therefore, the adapters are available in 3 colours. Characteristic features of the series are excellent optical and mechanical parameters as well as high quality.

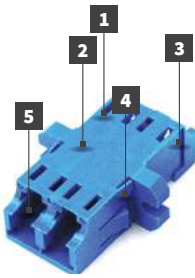

### Adapter construction

1. "Super One-Piece Design" technology
2. Anti-fungus material with the UL94-V0 flammability index
3. Housing available in 5 colours
4. Special wings for accurate fixation
5. Optional shutter (inner)



### Features

- One-Piece Design,
- Available in a duplex and quad version
- flange or flangeless configuration
- Special wings for accurate fixation
- Internal or external shutter for eye safety
- The highest quality and durability
- Excellent optical and mechanical parameters
- Colour coding according to the standards

## Premium Super One-Piece Class

LC Premium Super One-Piece adapters with the highest optical and mechanical parameters. The "super one-piece design" includes integrated non-metallic clips and 4 anti-rattle wings, which significantly reduce movement when snapped into a panel.

Adapters are available in 5 colours in a duplex design, with an optional flange. Therefore, the adapters are constructed from anti-fungus plastic with the UL94-V0 flammability index. The version is available with an inner shutter.

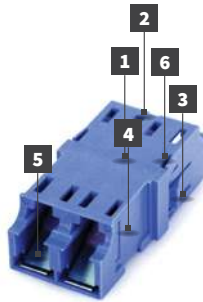

### Adapter construction

1. "Super One-Piece Design" technology
2. Anti-fungus plastic with the UL94-V0 flammability index
3. Integrated, non-metal clips
4. Housing available in 5 colours
5. Inner metal shutter
6. Special wings for accurate fixation



### Features

- One-piece design
- Special wings for accurate fixation
- flange or flangeless configuration
- Excellent optical and mechanical parameters
- The highest quality and durability
- Constructed from anti-fungus plastic with the UL94-V0 flammability index
- Equipped with an inner metal shutter for eyes protection

### ORDERING SYNTAX

| Class   | Connector type       | No. of fibers                | Shutter type  | Mounting                    | Sleeve   | Body colour  | Dust cover colour  |
|---|----------------------|------------------------------|---|-----------------------------|--|--|--|
| <b>A001 (standard One-Piece)</b>                    | LC (PC)<br>LCA (APC) | DX (Duplex)<br>4x (Quad)     | N/A   | 1 (flange)<br>2 (flangless) | 1 (ceramic)  | 1 (green SM APC)<br>2 (Blue SM PC)<br>5 (Beige MM OM1/2)<br>6 (Aqua MM OM3)<br>7 (Violet MM OM4) | 3 (Black)<br>T (transparent)<br>S (Semi-transparent)     |
| <b>AS01 (Premium One-Piece)</b>                     |                      |                              | N/A   |                             |  | 1 (ceramic)<br>2 (metal)   | 1 (green SM APC)<br>2 (Blue SM PC)<br>5 (Beige MM OM1/2) |
| <b>AS02 (Premium One-Piece with ext. shutters)</b>  |                      |                              | 1 (Internal)<br>2 (External)  |                             | 1 (green SM APC)<br>2 (Blue SM PC)<br>5 (Beige MM OM1/2) |  |  |
| <b>A031 (Premium Super One-Piece)</b>               |                      | N/A                          | 1 (green SM APC)<br>2 (Blue SM PC)<br>5 (Beige MM OM1/2)<br>6 (Aqua MM OM3) |                             |  |  |  |
| <b>AS31 (Premium Super One-Piece with shutters)</b> |                      | 1 (Internal)<br>2 (External) |   |                             |  |  |  |

## Example

AS01-LC-DX-11128 FIBRAIN LC PC SM adapter, DX, Premium One-Piece, internal shutter, with flange, ceramic sleeve, blue housing, white dust cover.

# E2000™ adapters

Fiber optic adapters are designed to combine E2000™ connectors with a push&pull mechanism, which provides fast and stable connection, and prevents accidental disconnects. The E-2000™ adapter features injection-molded PBT housing, rated to the UL94-V0 flammability index. Spring-loaded laser protection shutters protect against dust and scratching as well as guarantee protection for the eyes.

A high quality ceramic alignment sleeve ensures high performance over 1000 mating cycles. Adapters are equipped with a semi-transparent plastic dust cover, providing optical testing with test lasers without removing the cover. The adapters comply with PN/IEC 61754 and DIN/EN 186270 standards.

## Available colours



| ELECTRICAL AND MECHANICAL PARAMETERS |                 |           |
|--------------------------------------|-----------------|-----------|
| Parameter                            | E2000™ SM       | E2000™ MM |
| Insertion Loss $IL_{MAX}$            | 0.20 dB         | 0.30 dB   |
| Insertion Loss $IL_{TYP}$            | 0.10 dB         | 0.15 dB   |
| Alignment sleeve                     | aceramic        | ceramic   |
| Durability                           | 1000 matings    |           |
| Operating temperature                | -40 up to +85°C |           |
| Strength of coupling mechanism       | 70N             |           |
| Inner shutter                        | ☑               | ☑         |

## Types of E2000™ adapters

| Code    | Adapter type   |
|---------|--|
| R504511 | E2000 SM PC, blue housing, flange, ceramic sleeve      |
| R504541 | E2000 SM APC, green housing, flange, ceramic sleeve    |
| R504562 | E2000 SM APC, green housing, no flange, ceramic sleeve |
| R508019 | E2000 MM PC, black housing, flange, ceramic sleeve     |



### Features

- Equipped with integral self-closing metal laser protection internal shutter, which guarantees protection for the eyes and against dust,
- Excellent optical parameters,
- Mounting with the use of M2 screws or quick mounting by integrated clip (possibility of flangeless adapters),
- Constructed from highly resistant and durable PBT material with UL94-V0 flammability index,
- High quality ceramic alignment sleeve ensures high performance over 1000 mating cycles.

### Insertion loss

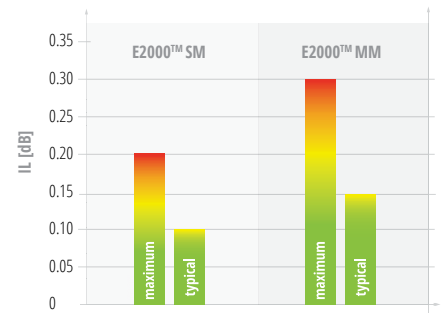

### Durability

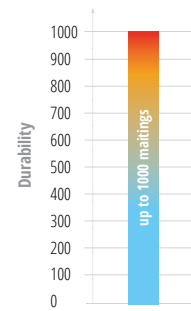

### Strength of coupling mechanism

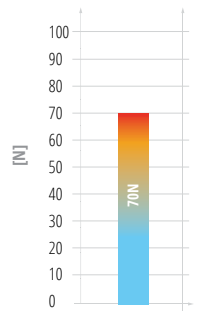

# FC&ST adapters

## FC adapters

FC connection elements are specifically designed for telecommunication elements, where stable connection is necessary and performed with the use of a thread mechanism. The FC connector is screwed in, which eliminates the possibility of an accidental disconnect.

Therefore, the FC FIBRAIN optic fiber adapters have excellent optical and mechanical parameters as they are constructed from high quality materials. The FC adapters are designed for single- and multimode application with high quality of alignment sleeve.



| ORDERING SYNTAX |              |      |          |           |                |                   |
|-----------------|--------------|------|----------|-----------|----------------|-------------------|
| Series          | Adapter type | Type | Mounting | Sleeve    | Housing Colour | Dust cover Colour |
| A151-Standard   | FC           | SX   | 3 d-hole | 1 ceramic | 0 - metal      | 1 green           |
| A161-Premium    | FCA          |      |          | 2 metal   |                | 3 black           |
|                 |              |      |          |           |                | 4 red             |

### Example

**A151-FCA-SX-3101** FIBRAIN FC APC SM adapter, SX, Standard Series, d-hole mounting, ceramic sleeve, metal housing, green dust cover.

## ST adapters

ST FIBRAIN optic adapters are the elements of the fiber optic system, which are used to connect ST connectors using a bayonet mechanism. The ST adapters are characterized by the high quality of the external non-metal housing and alignment sleeve.

Adapters are available for singlemode and multimode applications.

Adapters are precision-made items with excellent optical and mechanical parameters.



| ORDERING SYNTAX |              |      |          |           |                |                   |
|-----------------|--------------|------|----------|-----------|----------------|-------------------|
| Series          | Adapter type | Type | Mounting | Sleeve    | Housing Colour | Dust cover Colour |
| A181-Standard   | ST           | SX   | 3 d-hole | 1 ceramic | 0 - metal      | 3 black           |
| A191-Premium    |              |      |          | 2 metal   |                | 4 red             |

### Example

**A181-ST-SX-3103** FIBRAIN ST PC SM adapter, SX, Standard Series, d-hole mounting, ceramic sleeve, metal housing, black dust cover.

| ELECTRICAL AND MECHANICAL PARAMETERS       |   |  |
|--|---|--|
| Parameter                                  | Standard                                | Premium                                  |
| Insertion Loss<br>$IL_{MAX}$               | 0.30 dB                                 | 0.20 dB                                  |
| Insertion Loss<br>$IL_{TYP}$               | 0.15 dB                                 | 0.10 dB                                  |
| Repeatability<br>$\Delta IL$ /mating cycle | $\pm 0.10$ dB                           | $\pm 0.08$ dB                            |
| Durability                                 | 500 matings/<br><0.20 dB typical change | 1000 matings/<br><0.15 dB typical change |
| Alignment sleeve                           | ceramic/metal                           |  |
| Operating temperature                      | -40 up to +85°C                         |  |
| Mounting                                   | d-hole                                  |  |

### Features

- Excellent optical and mechanical parameters
- High quality
- Thread or bayonet mount mechanism providing constant and stable connection
- High quality ceramic sleeve for singlemode and phosphor-metal sleeve for multimode applications
- Constructed from material resistant to corrosion

### Insertion loss

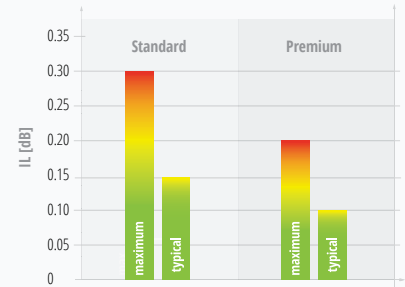

### Durability

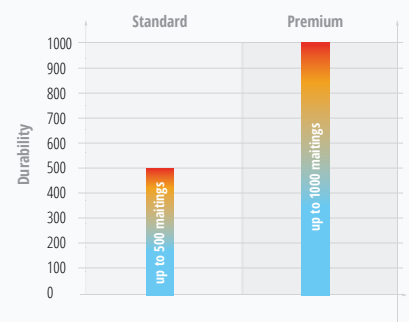

# MTP® adapters



## Main features

- Adapters provide quick connection of MTP®/ MPO connectors – connection integrity is provided by adapter latches which are locked into place on the connectors by a spring loaded sliding mechanism
- One-piece design of adapter body – increased side loading performance
- Available in black, aqua, beige, violet magenta and green
- Flange or flangeless configuration
- Opposed key orientation - TIA 604-5D (on request aligned key orientation in gray housing Colour)
- Standard MTP footprint type (on request MTP adapters in SC footprint type available)

## Applications

- Data Center Systems
- Array trunk cabling
- Dense interconnect for data center and telecommunication system
- Chassis-to-chassis connections
- Structured cabling per TIA-568-C

## Available colours



## Features

- Low insertion loss
- Meets IEC Standard 61754-7
- Meets TIA/EIA 604-5 Type MPO
- Push-pull mechanism provides quick connections

## Ordering information

| Code            | Adapter type   |
|-----------------|--|
| AD-MTP-SM-GR-F  | FIBRAIN MTP SM adapter, flange, green housing, opposed key   |
| AD-MTP-OM1-BG-F | FIBRAIN MTP OM1 adapter, flange, beige housing, opposed key  |
| AD-MTP-OM2-BK-F | FIBRAIN MTP OM2 adapter, flange, black housing, opposed key  |
| AD-MTP-OM3-AQ-F | FIBRAIN MTP OM3 adapter, flange, aqua housing, opposed key   |
| AD-MTP-OM4-V-F  | FIBRAIN MTP OM4 adapter, flange, violet housing, opposed key |



# Field terminable connectors

FIBRAIN Rapid Connectors are specifically designed to terminate optical fibers in installation place. The Rapid Connector is a pre-polished, pre-assembled connector compatible with the standard LC&SC connectors. Total assembly time together with fiber preparation do not exceeds 120 seconds, and requires no extra tools. The ferrules are factory polished, thus no extra polishing materials are necessary. Also the clamp system in the V-grooves, where immersion gel is placed, eliminates the necessity to use other adhesives or epoxy gel and improves the transmission parameters. High quality index matching gel, whose refractive index is close to refractive index of the core of optical fiber, significantly improves Return Loss.

The FIBRAIN Rapid Connector series includes the connectors which can be used to terminate single-mode and multimode optical fibers in 250 μm and 900 μm coating. Moreover, the series is equipped with a special connector construction specifically designed for VC-DCY Drop cables, which are used in FTTH systems. The connectors are mounted on an external cable sheath, not only on a fiber in 250 μm covering, which guarantees higher protection of a connection and eliminate possibility of breaking the fiber.

Excellent transmission parameters, easy assembly in installation place and time saving, are only some benefits of the new series of FIBRAIN Rapid Connector.

| ORDERING SYNTAX |                |        |            |                    |                     |
|-----------------|----------------|--------|------------|--------------------|---------------------|
| Series          | Connector type |        | Fiber type |                    | Cable type          |
| RC01            | 1              | SC PC  | 1          | SM 9/125 μm        | 1 250/900 μm        |
|                 | 2              | SC APC | 2          | MM 50/125 μm OM2   | 2 Drop cable VC-DCY |
|                 | 3              | LC PC  | 3          | MM 62.5/125 μm OM1 |                     |
|                 |                |        | 4          | MM 50/125 μm OM3   |                     |

## Example

**RC01-212** FIBRAIN Rapid Connector SC APC for VC-DCY Drop cables.

## Additional accessories

**RC01- J Assembly Adapter** Provides proper stripping length during Rapid Connector's assembly on VC-DCY Drop cables



## Available colours

According to fiber type (multimode/single mode –grey&black/ blue&green)

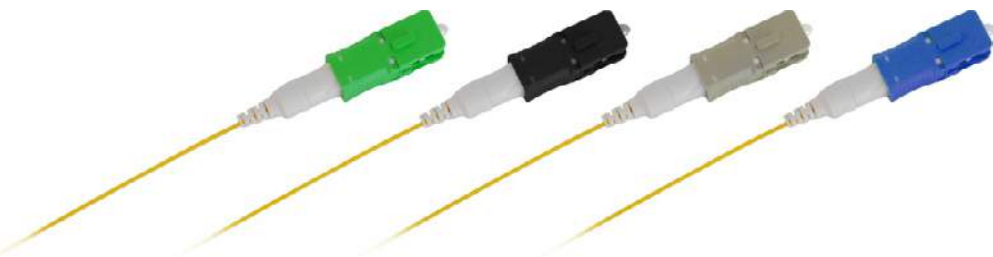

### Applications

- LAN networks
- WAN networks
- FTTH networks
- Telecommunication networks
- CATV networks
- Intra-building

### Features

- Termination time does not exceed 120 s
- Easy and fast assembly
- Excellent transmission parameters
- High quality materials
- A ferrule polished in a Premium Class has excellent ferrule end face geometry parameters
- A termination is performed with a use of standard equipment
- Durability and resistance of the matching gel for even 25 years
- Exceeds TIA/EIA-568-B.3 standards

### TECHNICAL SPECIFICATIONS

| Parameter                           | Connectors              |         |         |
|-------------------------------------|-------------------------|---------|---------|
|                                     | SM PC                   | SM APC  | MM PC   |
| Insertion Loss<br>IL <sub>typ</sub> | 0.20 dB                 | 0.30 dB | 0.10 dB |
| Return Loss<br>RL                   | 55 dB                   | 60 dB   | 35 dB   |
| Durability                          | < 0.10 dB / 500 matings |         |         |
| Operating temperature               | -40 to +75°C            |         |         |
| Connector type                      | SC, SCA, LC             |         |         |

**FIBER  
OPTIC**



**PRECONNECTORIZED**

# PRECONNECTORIZED

Perfect Plug&Play solutions for fiber optic networks



**RELIABLE SOLUTION**



**DIFFERENT  
INDOOR/OUTDOOR  
CONSTRUCTIONS FOR  
DIFFERENT APPLICATIONS**



**PLUG&PLAY SOLUTION FOR  
TIME SAVING INSTALLATIONS**

# CABLES

# CABLES



THE HIGHEST PERFORMANCE  
OF FACTORY TERMINATED PLUGS











FULL RANGE  
OF THE CONNECTORS  
INCLUDING MPO/MTP





100% TESTS  
IN QUALITY CONTROL  
PROCEDURES

# Gold Grade Patch Cords

## Patch cord connectors range

|   |   |   |
|---|---|---|
|  |  |  |
| SC  | SCA   | LC  |
|  |  |  |
| FC  | FCA   | E2  |
|  |  |   |
| E2A   | DIN   |   |

## Ordering syntax

| ORDERING SYNTAX |           |     |               |            |                      |              |                |        |   |
|-----------------|-----------|-----|---------------|------------|----------------------|--------------|----------------|--------|---|
| Series          | Connector |     | Boot type     | Length [m] | Cable                | Fiber        | Cable diameter | Colour |   |
|                 | A         | B   |               |            |                      |              |                |        |   |
| G-Gold          | SC        | SC  | S-Standard    | xxx.x      | SX patchcord simplex | A SMF G.652D | 16 1.6 mm      | OR     |  |
|                 | SCA       | SCA | M-Mini        |            | DX patchcord duplex  | B SMF G655   | 18 1.8 mm      | Y      |  |
|                 | LC        | LC  | F-Flex-angled |            |                      | C SMF G656   | 28 2.8 mm      |        |   |
|                 | LCA       | LCA |               |            |                      | D SMF G657A1 |                |        |   |
|                 | FC        | FC  |               |            |                      | E SMF G657A2 |                |        |   |
|                 | FCA       | FCA |               |            |                      | F SMF G657B2 |                |        |   |
|                 | E2        | E2  |               |            |                      | G SMF G657B3 |                |        |   |
|                 | E2A       | E2A |               |            |                      | H MMF OM1    |                |        |   |
|                 | DIN       | DIN |               |            |                      | I MMF OM2    |                |        |   |
|                 |           |     |               |            |                      | J MMF OM2+   |                |        |   |
|                 |           |     |               |            | K MMF OM3            |              |                |        |   |
|                 |           |     |               |            | L MMF OM4            |              |                |        |   |

## Example

**G-SCA-SCA-S-002.0-SX-A-18-Y** FIBRAIN Gold Grade Patchcord, with SC APC connectors at both side, simplex, 2m length, G.652D, 1.8 mm cable diameter, yellow coat

### Description

FIBRAIN optical components are specifically designed and based on connectors, which comply with IEC/ PN-EN 61754 and IEC/PN -EN 61755 requirements. Gold grade patch cords are available in singlemode and multi-mode option with various type of connectors, cables and optical fibers. Fully automated preparation and polishing process ensure the highest quality and reliability. Therefore, detailed selection of the manufacturing components ensures the highest quality of the product. Gold grade patch cords are available with 3 different designs of boots, which protect the bend radius of the optical fibers. Apart from standard boots, there are mini and flexi-angle available. The boot in the mini option limits the total length of a connector and boot, whereas the flexi-angle boot is designed to bend in a 0-90° angle range. Available options of the boots are given in the table below. There is no possibility to mix various types of boots on a patchcord- as from the both sides a patchcord is terminated with the same type of boots.

### Applications

- Telecommunication networks
- Local area network (LAN)
- FTTx, FTTD, FTTB, FTTH networks
- CATV solutions
- CWDM networks

### Features

- Comply with IEC, TIA/EIA requirements
- High quality and repeatability of the transmission parameters
- Connectors are constructed from high quality plastic, resistant to corrosion and high temperatures with UL94-V0 flammability index or the high quality metal resistant to corrosion
- Wide range of available fibers and connectors

### TECHNICAL SPECIFICATIONS

| Parameter   | Connectors |           |           |
|---|------------|-----------|-----------|
|   | SM PC      | SM APC    | MM PC     |
| <b>Insertion Loss</b><br>IL <sub>MAX</sub> against MASTER<br>Acc. IEC 61300-3-4 | ≤ 0.17 dB  | ≤ 0.20 dB | ≤ 0.20 dB |
| <b>Insertion Loss</b><br>IL <sub>TYP</sub> against MASTER<br>Acc. IEC 61300-3-4 | ≤ 0.15 dB  | ≤ 0.16 dB | ≤ 0.12 dB |
| <b>Return Loss</b><br>Acc. IEC 61300-3-6  | ≥ 55 dB    | ≥ 65 dB   | ≥ 35 dB   |

# Titanium Grade Patch Cords

## Patch cord connectors range

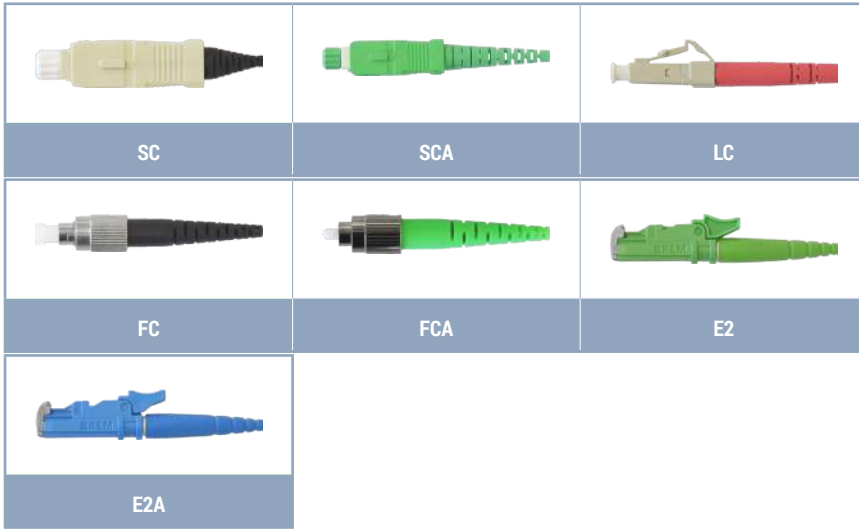

## Ordering syntax

| ORDERING SYNTAX |           |     |               |            |                      |              |                |        |  |
|-----------------|-----------|-----|---------------|------------|----------------------|--------------|----------------|--------|--|
| Series          | Connector |     | Boot type     | Length [m] | Cable                | Fiber        | Cable diameter | Colour |  |
|                 | A         | B   |               |            |                      |              |                |        |  |
| T-Titanium      | SC        | SC  | S-standard    | xxx.x      | SX patchcord simplex | A SMF G.652D | 16 1.6 mm      | OR     |  |
|                 | SCA       | SCA | M-Mini        |            | DX patchcord duplex  | B SMF G655   | 18 1.8 mm      | Y      |  |
|                 | LC        | LC  | F-Flex-angled |            |                      | C SMF G656   | 28 2.8 mm      |        |  |
|                 | LCA       | LCA |               |            |                      | D SMF G657A1 |                |        |  |
|                 | FC        | FC  |               |            |                      | E SMF G657A2 |                |        |  |
|                 | FCA       | FCA |               |            |                      | F SMF G657B2 |                |        |  |
|                 | E2        | E2  |               |            |                      | G SMF G657B3 |                |        |  |
|                 | E2A       | E2A |               |            |                      | H MMF OM1    |                |        |  |
|                 |           |     |               |            |                      | I MMF OM2    |                |        |  |
|                 |           |     |               |            |                      | J MMF OM2+   |                |        |  |
|                 |           |     |               |            |                      | K MMF OM3    |                |        |  |
|                 |           |     |               |            |                      | L MMF OM4    |                |        |  |

## Example

T-SCA-SCA-S-002.0-SX-D-28-Y FIBRAIN Titanium Grade Patchcord, with SC APC connectors at both side, simplex, 2m length, G.657A1, 2.8 mm cable diameter, yellow coat

### Description

FIBRAIN Titanium series of patchcords and pigtails is intended for the most demanding customers. High optical parameters, premium quality and precise selection of the components are the characteristic features of the Titanium Grade. FIBRAIN optical components are specifically designed and based on connectors, which comply with IEC/ PN-EN 61754 and IEC/PN –EN 61755 requirements. Patchcords and pigtails of Titanium Grade are available in singlemode option with various type of connectors, cables and optical fibers. Fully automated preparation and polishing process ensure the highest quality and reliability. Therefore, detailed selection of the manufacturing components ensures the highest quality of the final component.

### Applications

- Telecommunication networks
- Local area network (LAN)
- FTTx, FTTD, FTTB, FTTH networks
- CATV solutions
- CWDM networks
- Low voltage networks
- Measuring devices

### Features









- Comply with IEC, TIA/EIA requirements
- High quality and repeatability of the transmission parameters
- Connectors are constructed from high quality plastic, resistant to corrosion and high temperatures with flammability index UL94-V0 or the high quality metal resistant to corrosion
- High quality ceramic ferrules
- Low attenuation and high reflectance
- Wide range of available connectors and optical fibers

### TECHNICAL SPECIFICATIONS

| Parameter  | Connectors |           |
|--|------------|-----------|
|  | SM PC      | SM APC    |
| Insertion Loss<br>IL <sub>MAX</sub> against MASTER<br>Acc. IEC 61300-3-4 | ≤ 0.12 dB  | ≤ 0.20 dB |
| Insertion Loss<br>IL <sub>TYP</sub> against MASTER<br>Acc. IEC 61300-3-4 | ≤ 0.10 dB  | ≤ 0.16 dB |
| Return Loss<br>Acc. IEC 61300-3-6  | ≥ 55 dB    | ≥ 65 dB   |

# Gold Grade Pigtails

## Pigtail connectors range

|   |   |   |
|---|---|---|
|  |  |  |
| SC  | SCA   | LC  |
|  |  |  |
| FC  | FCA   | E2  |
|  |  |   |
| E2A   | DIN   |   |

## Ordering syntax

| ORDERING SYNTAX |           |    |               |            |                          |              |                |        |   |
|-----------------|-----------|----|---------------|------------|--------------------------|--------------|----------------|--------|---|
| Series          | Connector |    | Boot type     | Length [m] | Cable                    | Fiber        | Cable diameter | Colour |   |
|                 | A         | B  |               |            |                          |              |                |        |   |
| G-Gold          | SC        | XX | S-Standard    | xxx.x      | P9 pigtail 900 µm        | A SMF G.652D | 09 0.9 mm      | GR     |  |
|                 | SCA       |    | M-Mini        |            | PS pigtail simplex cable | B SMF G655   |                | GY     |  |
|                 | LC        |    | F-Flex-angled |            | PD pigtail duplex cable  | C SMF G656   |                | BL     |  |
|                 | LCA       |    |               |            |                          | D SMF G657A1 |                | BK     |  |
|                 | FC        |    |               |            |                          | E SMF G657A2 |                | V      |  |
|                 | FCA       |    |               |            |                          | F SMF G657B2 |                | R      |  |
|                 | E2        |    |               |            |                          | G SMF G657B3 |                | W      |  |
|                 | E2A       |    |               |            |                          | H MMF OM1    |                | AQ     |  |
|                 | DIN       |    |               |            |                          | I MMF OM2    |                | BR     |  |
|                 |           |    |               |            |                          | J MMF OM2+   |                | P      |  |
|                 |           |    |               |            |                          | K MMF OM3    |                |        |   |
|                 |           |    |               |            |                          | L MMF OM4    |                |        |   |

## Example

**G-SCA-XX-M-001.0-P9-A-09-GR** FIBRAIN Gold Grade pigtail, with SC APC connector, Mini boot, 2 m length, G.652D, simplex, 0.9 mm cable diameter, green coat

## Description

FIBRAIN optical components are specifically designed and based on connectors, which comply with IEC/ PN-EN 61754 and IEC/PN-EN 61755 requirements. Gold grade patch cords are available in singlemode and multi-mode option with various type of connectors, cables and optical fibers. Fully automated preparation and polishing process ensure the highest quality and reliability. Therefore, detailed selection of the manufacturing components ensures the highest quality of the product. Gold grade patch cords are available with 3 different designs of boots, which protect the bend radius of the optical fibers. Apart from standard boots, there are mini and flexi-angle available. The boot in the mini option limits the total length of a connector and boot, whereas the flexi-angle boot is designed to bend in a 0-90° angle range. Available options of the boots are given in the table below. There is no possibility to mix various types of boots on a patchcord- as from the both sides a patchcord is terminated with the same type of boots.

## Applications

- Telecommunication networks
- Local area network (LAN)
- FTTx, FTTD, FTTB, FTTH networks
- CATV solutions
- CWDM networks

## Features

- Comply with IEC, TIA/EIA requirements
- High quality and repeatability of the transmission parameters
- Connectors are constructed from high quality plastic, resistant to corrosion and high temperatures with UL94-V0 flammability index or the high quality metal resistant to corrosion
- Wide range of available fibers and connectors

## TECHNICAL SPECIFICATIONS

| Parameter   | Connectors |           |           |
|---|------------|-----------|-----------|
|   | SM PC      | SM APC    | MM PC     |
| <b>Insertion Loss</b><br>IL <sub>MAX</sub> against MASTER<br>Acc. IEC 61300-3-4 | ≤ 0.17 dB  | ≤ 0.20 dB | ≤ 0.20 dB |
| <b>Insertion Loss</b><br>IL <sub>TYP</sub> against MASTER<br>Acc. IEC 61300-3-4 | ≤ 0.15 dB  | ≤ 0.16 dB | ≤ 0.12 dB |
| <b>Return Loss</b><br>Acc. IEC 61300-3-6  | ≥ 55 dB    | ≥ 65 dB   | ≥ 35 dB   |

# Titanium Grade Pigtails

## Patch cord connectors range

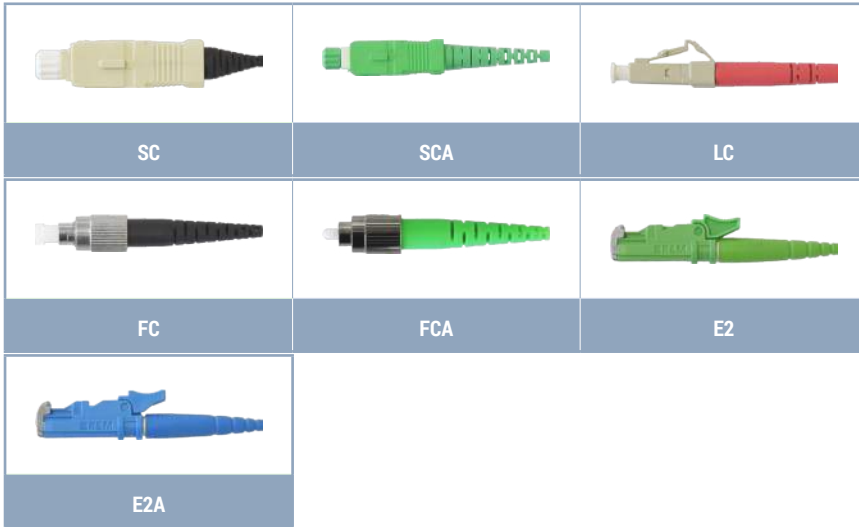

## Ordering syntax

| ORDERING SYNTAX |           |    |               |            |                          |              |                |        |  |
|-----------------|-----------|----|---------------|------------|--------------------------|--------------|----------------|--------|--|
| Series          | Connector |    | Boot type     | Length [m] | Cable                    | Fiber        | Cable diameter | Colour |  |
|                 | A         | B  |               |            |                          |              |                |        |  |
| T-Titanium      | SC        | XX | S-standard    | xxx.x      | P9 pigtail 900 μm        | A SMF G.652D | 09 0.9 mm      | GR     |  |
|                 | SCA       |    | M-Mini        |            | PS pigtail simplex cable | B SMF G655   |                | GY     |  |
|                 | LC        |    | F-Flex-angled |            | PD pigtail duplex cable  | C SMF G656   |                | BL     |  |
|                 | LCA       |    |               |            |                          | D SMF G657A1 |                | BK     |  |
|                 | FC        |    |               |            |                          | E SMF G657A2 |                | V      |  |
|                 | FCA       |    |               |            |                          | F SMF G657B2 |                | R      |  |
|                 | E2        |    |               |            |                          | G SMF G657B3 |                | W      |  |
|                 | E2A       |    |               |            |                          | H MMF OM1    |                | AQ     |  |
|                 |           |    |               |            |                          | I MMF OM2    |                | BR     |  |
|                 |           |    |               |            |                          | J MMF OM2+   |                | P      |  |
|                 |           |    |               |            |                          | K MMF OM3    |                |        |  |
|                 |           |    |               |            |                          | L MMF OM4    |                |        |  |

## Example

**T-SCA-SCA-S-001.0-M-A-09-GR** FIBRAIN Titanium Grade Pigtail, with SC APC connector, Mini boot, 2 m length, G.652D, 0.9 mm cable diameter, green coat

## Description

FIBRAIN optical components are specifically designed and based on connectors, which comply with IEC/ PN-EN 61754 and IEC/PN -EN 61755 requirements. Gold grade patch cords are available in singlemode and multi-mode option with various type of connectors, cables and optical fibers. Fully automated preparation and polishing process ensure the highest quality and reliability. Therefore, detailed selection of the manufacturing components ensures the highest quality of the product. Gold grade patch cords are available with 3 different designs of boots, which protect the bend radius of the optical fibers. Apart from standard boots, there are mini and flexi-angle available.

## Applications

- Telecommunication networks
- Local area network (LAN)
- FTx, FTTD, FTB, FTH networks
- CATV solutions
- CWDM networks
- Low voltage networks
- Measuring devices

## Features

- Comply with IEC, TIA/EIA requirements
- High quality and repeatability of the transmission parameters
- Connectors are constructed from high quality plastic, resistant to corrosion and high temperatures with flammability index UL94-V0 or the high quality metal resistant to corrosion
- High quality ceramic ferrules
- Low attenuation and high reflectance
- Wide range of available connectors and optical fibers

## TECHNICAL SPECIFICATIONS

| Parameter  | Connectors |           |
|--|------------|-----------|
|  | SM PC      | SM APC    |
| Insertion Loss<br><b>IL<sub>MAX</sub></b> against MASTER<br>Acc. IEC 61300-3-4 | ≤ 0.12 dB  | ≤ 0.20 dB |
| Insertion Loss<br><b>IL<sub>TYP</sub></b> against MASTER<br>Acc. IEC 61300-3-4 | ≤ 0.10 dB  | ≤ 0.16 dB |
| Return Loss<br>Acc. IEC 61300-3-6  | ≥ 55 dB    | ≥ 65 dB   |

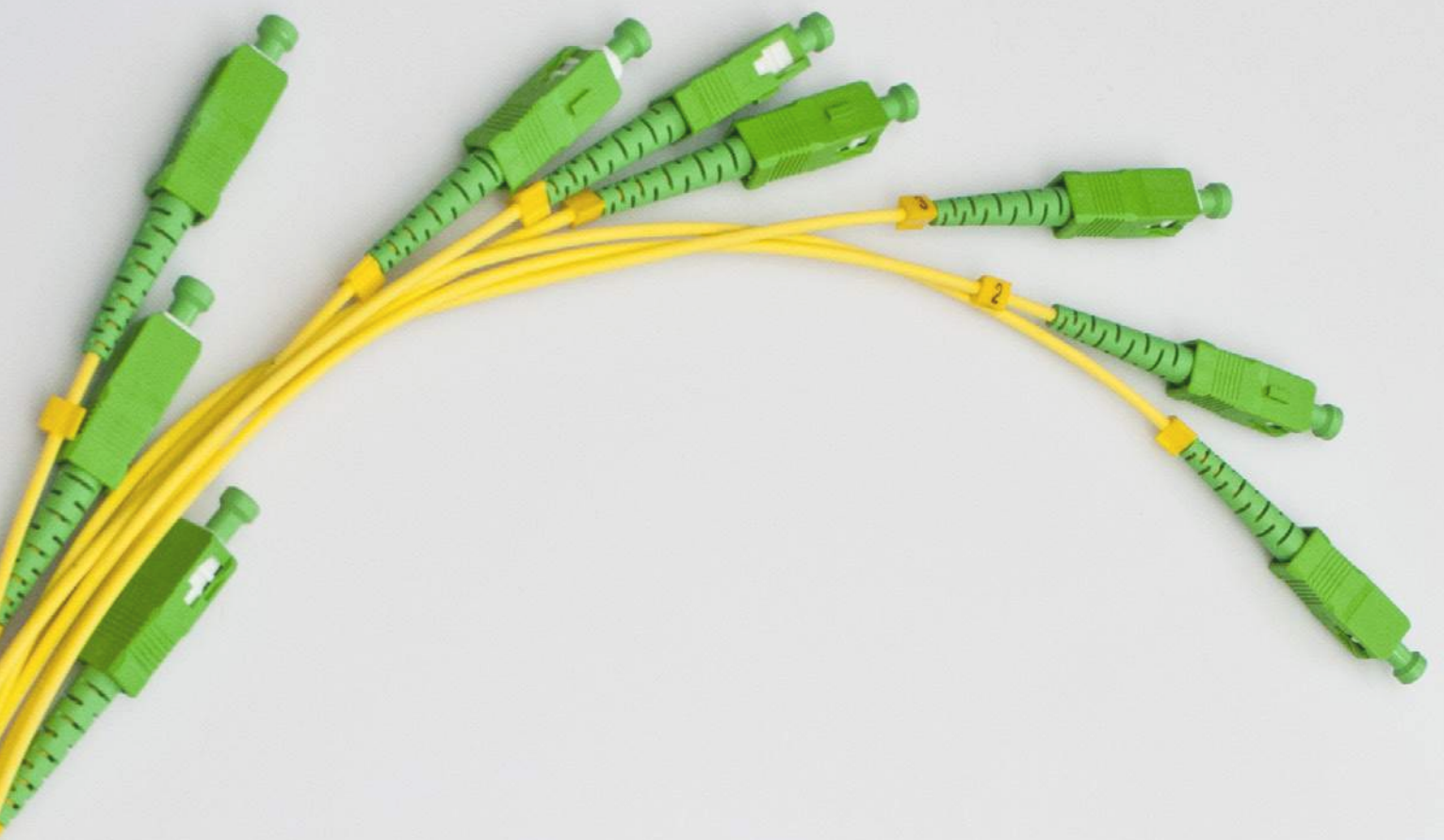



# Pigtail set

## PIGTAIL SET



### Pigtail Set with a standard 900 µm colorful protection tube

| Available colours of tubes |       |      |        |       |      |       |        |        |       |      |      |
|----------------------------|-------|------|--------|-------|------|-------|--------|--------|-------|------|------|
|                            |       |      |        |       |      |       |        |        |       |      |      |
| red                        | green | blue | yellow | white | grey | brown | violet | orange | black | pink | aqua |

| ORDERING SYNTAX |           |    |            |            |                   |              |                |                |   |  |
|-----------------|-----------|----|------------|------------|-------------------|--------------|----------------|----------------|---|--|
| Series          | Connector |    | Boot type  | Length [m] | Cable             | Fiber        | Cable diameter | Colour         |   |  |
|                 | A         | B  |            |            |                   |              |                |                |   |  |
| G-SET12         | SC        | XX | S-Standard | xxx.x      | P9 pigtail 900 µm | A SMF G.652D | 09 0.9 mm      | 12 multi-color |   |  |
|                 | SCA       |    |            |            |                   |              |                |                | Y |  |
|                 | LC        |    |            |            |                   |              |                |                |   |  |
|                 | LCA       |    |            |            |                   |              |                |                |   |  |
|                 | FC        |    |            |            |                   |              |                |                |   |  |
|                 | FCA       |    |            |            |                   |              |                |                |   |  |
|                 | E2        |    |            |            |                   |              |                |                |   |  |
|                 | E2A       |    |            |            |                   |              |                |                |   |  |
|                 | ST        |    |            |            |                   |              |                |                |   |  |

### Example

**G-SET12-SCA-XX-S-002.0-P9-A-09-12** FIBRAIN Pigtail Gold, SET 12 pieces, SC APC connector, G.652D, 2m length, 0.9 mm tube in 12 colors

## Patch Cords & Pigtails

### Description

The set of 12 fiber optic pigtails polished in the Gold grade. This set is available in two versions: 12 pigtails in yellow protection tube 0.9 mm or a set of 12 pigtails with multicolor 0.9 mm protection tubes. The set of pigtails facilitates the assembly and identification of fiber optic splices, which saves installation time and lower the costs substantially. The tubes are available in the following colors: red, green, blue, yellow, white, grey, brown, purple, orange, black, pink, aqua.

### Applications

- Telecommunication networks
- Local area network (LAN)
- FTx, FTTD, FTB, FTTH networks
- CATV solutions
- CWDM networks
- Low voltage networks
- Measuring devices

### Features

- Comply with IEC, TIA/EIA requirements,
- High quality and repeatability of the transmission parameters,
- Connectors are constructed from high quality plastic, resistant to corrosion and high temperatures with flammability index UL94-V0 or the high quality metal resistant to corrosion,
- High quality ceramic ferrules,
- Low attenuation and high reflectance,
- Wide range of available connectors and optical fibers.

### TECHNICAL SPECIFICATIONS

| Parameter   | Connectors |           |           |
|---|------------|-----------|-----------|
|   | SM PC      | SM APC    | MM PC     |
| <b>Insertion Loss</b><br>IL <sub>MAX</sub> against MASTER<br>Acc. IEC 61300-3-4 | ≤ 0.35 dB  | ≤ 0.35 dB | ≤ 0.35 dB |
| <b>Insertion Loss</b><br>IL <sub>TP</sub> against MASTER<br>Acc. IEC 61300-3-4  | ≤ 0.28 dB  | ≤ 0.28 dB | ≤ 0.25 dB |
| <b>Return Loss</b><br>Acc. IEC 61300-3-6  | ≥ 50 dB    | ≥ 60 dB   | ≥ 90 dB   |

# TCF Easylink 1 multipatchcords



## Mechanical and environmental characteristics

| Parameter                           | Standard   |  |
|-------------------------------------|--|--|
| Max. tensile load                   | IEC 61753-2-1  | 80N-fanout 1.8 mm/2.8 mm<br>7N- 900 µm tube            |
| Crush performance                   | EN 187101, IEC 60794-1-2-E3, no attenuation increase | 100N   |
| Installation temperature range      | EN 187101, IEC 60794-1-2-F1, no attenuation increase | -10... +50 [°C]  |
| Operation*                          | EN 187101, IEC 60794-1-2-F1, no attenuation increase | -30... +70 [°C]  |
| Transport & Storage                 |  | -30... +70 [°C]  |
| Max. Insertion Loss (per connector) | IEC 61300-3-4  | ≤ 0.3dB  |
| Return Loss (RL)                    | IEC 61300-3-6  | RL≥65 dB(APC);<br>RL≥50 dB(SM UPC);<br>RL≥30 dB(MM PC) |

\*Temperature range varies from the cable type.

## Technical specification

| Parameter                                 |                                |         |       |       |         |
|---|--------------------------------|---------|-------|-------|---------|
| Max. outer diameter of cable divider [mm] | Ø 15                           | Ø 18    | Ø 22* | Ø 24* | Ø 27*   |
| Length of cable divider [mm]              | 55                             | 65      | 65    | 70    | 80      |
| Number of fibers in 0.9mm tubes           | 4-48                           | 49-96** |       |       |         |
| Number of fibers in 1.8 mm fanouts        | 4-16                           | 17-32   | 33-48 | 49-60 | 61-96** |
| Number of fibers in 2.8mm fanouts         | 4-10                           | 11-18   | 19-26 | 27-32 | 33-48** |
| Connector type                            | SC/SCA/E2/E2A/LC/LCA/FC/FCA/ST |         |       |       |         |

\*Ø 22 - Ø 27 adapted to 1.8 - 2.8mm fanouts

\*\* There is a possibility of performing pre-connectorized cables with more fibers after consulting with our sales department.

### Description

→ Easylink 1 pre-connectorized multi-fiber cables are specifically designed to serve as general-purpose products. The solution provides termination of loose tube cables as well as other cable types. The fibers are inserted into 0.9mm tube or fanouts, strengthened by Kevlar fibers, with 1.8 mm or 2.8 mm (depending on a cable type). Therefore, the furcation point is protected by a heatshrink sleeve. Then, fibers are terminated with connectors in accordance with customer's needs and requirements.

→ In addition, from an economic point of view TCF cables provide cost-effective solutions, thus are popular in the structured cabling systems, where they are used as links between distribution points. It is a Plug and Play solution, which facilitates fast and easy installation, with no extra equipment, as in traditional installation with splices.

### Features

- Furcation point is protected by plastic tube and a heatshrink sleeve
- High quality
- Easy and fast installation
- Plug & Play solution
- Common in structured cable systems
- Wide range of fiber optic connectors

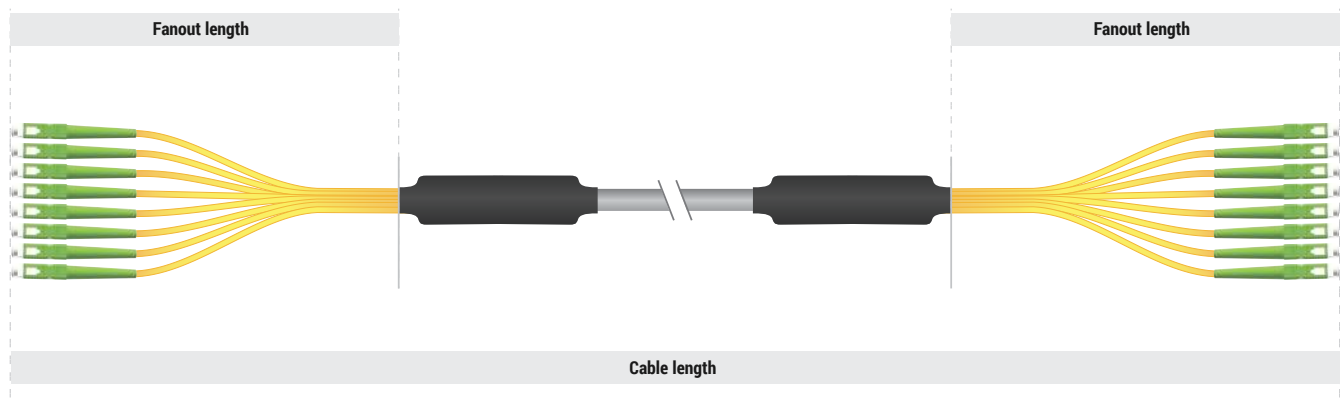

# TCF Easylink 1 multipatchcords

## Ordering syntax

TCF-**AABBB**-**CCDDD**-**EEF**-**XXXX.X**-**GYYYY**-**ZZZJ**

|   |                       |             |            |
|---|-----------------------|-------------|------------|
| <b>AA – Connectors qty (Side A)</b>     | 4-96                  |             |            |
| <b>BBB – Type of connector (Side A)</b> | SC-SC/PC              |             |            |
|   | SCA                   |             |            |
|   | E2                    |             |            |
|   | E2A                   |             |            |
|   | LC                    |             |            |
|   | LCA                   |             |            |
|   | FC                    |             |            |
|   | FCA                   |             |            |
|   | ST                    |             |            |
| <b>Connectors qty (Side B)</b>          | 4-96                  |             |            |
| <b>BBB – Type of connector (Side B)</b> | SC-SC/PC              |             |            |
|   | SCA                   |             |            |
|   | E2                    |             |            |
|   | E2A                   |             |            |
|   | LC                    |             |            |
|   | LCA                   |             |            |
|   | FC                    |             |            |
|   | FCA                   |             |            |
|   | ST                    |             |            |
| <b>EE – Cable type</b>                  | 01                    | EXO-CO PE   |            |
|   | 02                    | EXO-CO LSZH |            |
|   | 03                    | EXO-CI PE   |            |
|   | 04                    | EXO-CI LSZH |            |
|   | 05                    | BDC-CO PE   |            |
|   | 06                    | BDC-CO LSZH |            |
|   | 07                    | BDC-CI PE   |            |
|   | 08                    | BDC-CI LSZH |            |
|   | 24                    | BURRY DAC   |            |
|   | 28                    | AERO DF 03  |            |
|   | 35                    | FTTA DAC    |            |
|   | <b>F – Fibre type</b> | A           | SMF G.652D |
|   |                       | B           | SMF G655   |
|   |                       | C           | SMF G656   |
|   |                       | D           | SMF G657A1 |
| E                                       |                       | SMF G657A2  |            |
| F                                       |                       | SMF G657B2  |            |
| G                                       |                       | SMF G657B3  |            |
| L                                       |                       | MMF OM4     |            |

|   |               |                |
|---|---------------|----------------|
| <b>XXXX.X Cable length</b>                | <b>XXXX.X</b> |                |
| <b>G – Stepping (Side A)</b>              | 0 –           | equal length   |
|   | 1 –           | single cascade |
|   | 2 –           | double cascade |
| <b>YYY – Fan-out length (Side A) [cm]</b> | <b>yyy</b>    |                |
| <b>H – Fan-out diameter (Side A)</b>      | 0 –           | 0.9 mm         |
|   | 1 –           | 1.8 mm         |
|   | 2 –           | 2.8 mm         |
| <b>I – Stepping (Side B)</b>              | 0 –           | equal length   |
|   | 1 –           | single cascade |
|   | 2 –           | double cascade |
| <b>ZZZ – Fan-out length (Side B) [cm]</b> | <b>zzz</b>    |                |
| <b>J – Fan-out diameter (Side B)</b>      | 0 –           | 0.9 mm         |
|   | 1 –           | 1.8 mm         |
|   | 2 –           | 2.8 mm         |

Maximal outputs length in a standard configuration: 200 cm, minimal: 10 cm; for other outputs length please contact with our sales department.

| AVAILABLE CASCADES    |   |
|-----------------------|---|
| <b>Singe cascade</b>  | Each furcation leg is shorter by 3 cm than a previous one     |
| <b>Double cascade</b> | Pair of furcation legs is shorter by 3 cm than a previous one |

## Example

TCF-**12SCA**-**12SCA**-**01A**-**0100.0**-**01201**-**11200**

PTF pre-connectorized cable (EXO CO PE), SMF G.652D fibers, 100 m total length, pre-connectorized with 12xSC/APC connectors on both sides, Side A : equal length of all fan-out cables, fan-out length 120cm, diameter of each fan-out cable 1.8 mm, Side B: single cascade of fan-out, fan-out length 120 cm (of the longest cable), diameter of each fan-out cable 0.9 mm.

To order a non-standard option, please contact with our Sales Department.

# PTF Easylink 2 multipatchcords



## Mechanical and environmental characteristics

| Parameter                           | Standard   |  |
|-------------------------------------|--|--|
| Max. tensile load                   | IEC 61753-2-1  | 100N   |
| Crush performance                   | EN 187101, IEC 60794-1-2-E3, no attenuation increase | 1000N  |
| Installation temperature range      | EN 187101, IEC 60794-1-2-F1, no attenuation increase | -10... +50 [°C]  |
| Operation*                          | EN 187101, IEC 60794-1-2-F1, no attenuation increase | -30... +70 [°C]  |
| Transport & Storage                 |  | -30... +70 [°C]  |
| Max. Insertion Loss (per connector) | IEC 61300-3-4  | ≤ 0.3dB  |
| Return Loss (RL)                    | IEC 61300-3-6  | RL≥65 dB(APC);<br>RL≥50 dB(SM UPC);<br>RL≥30 dB(MM PC) |

\*Temperature range varies from the cable type.

## Technical specification

| Parameter                                   |                                |      |
|---|--------------------------------|------|
| Max. outer diameter of furcation point [mm] | Ø 18                           | Ø 21 |
| Length of furcation point                   | 90                             | 100  |
| Number of fibers in fanouts                 | 1-12                           | 1-24 |
| Connector type                              | SC/SOA/E2/E2A/LC/LCA/FC/FCA/ST |      |

\*Ø 22 - Ø 27 adapted to 1.8 - 2.8mm fanouts

\*\* There is a possibility of performing pre-connectorized cables with more fibers after consulting with our sales department.

### Description

- Easylink 2 pre-connectorized multi-fiber cables are specifically designed to serve as general-purpose products. The solution provides termination of loose tube cables as well as other cable types. The fibers are inserted into 0.9mm tube or furcation, strengthened by Kevlar fibers, with 1.6mm or 2.8mm (depending on a cable type). Therefore, the furcation point is protected by a metal sleeve with a boot protecting from moving and bending. Then, fibers are terminated with connectors in accordance with customer's needs and requirements. Moreover, output legs are placed inside a reusable protection tube, which is fixed to a bushing and may be used as a pulling grip.
- In addition, from an economic point of view PTF-Easylink2 cables provide cost-effective solutions, thus they are popular in the structured cabling systems, where they are used as links between distribution points. It is a Plug and Play solution, which facilitates fast and easy installation, with no extra equipment, as in traditional installation with splices.

### Features

- Furcation point is protected by plastic tube and a heatshrink sleeve,
- High quality,
- Easy and fast installation,
- Plug & Play solution,
- Common in structured cable systems,
- Wide range of fiber optic connectors.

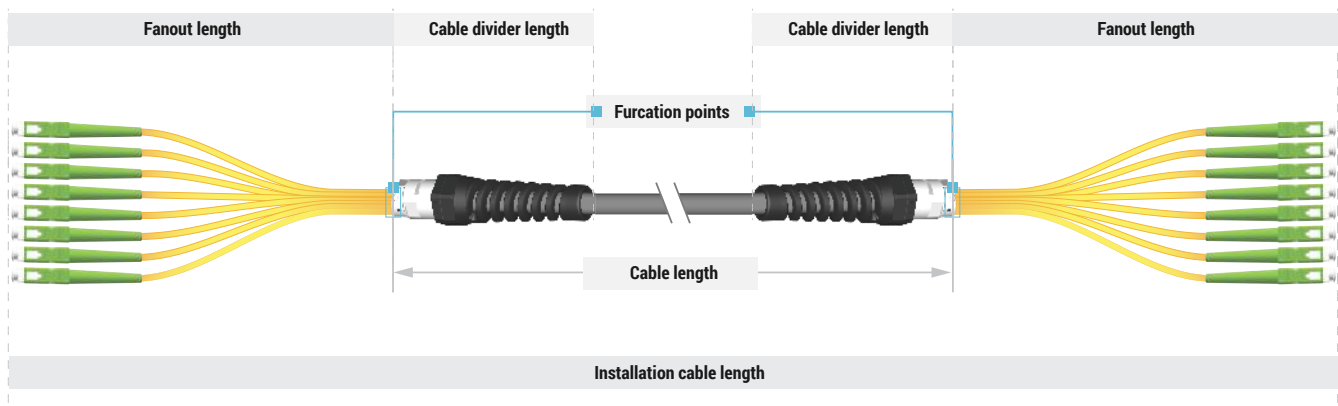

# PTF Easylink 2 multipatchcords

## Ordering syntax

PTF-**A****ABB**-**CC****DD**-**EE**-**XXXX.X**-**G****YYYH**-**IZZ****J**

|   |                       |             |            |
|---|-----------------------|-------------|------------|
| <b>AA – Connectors qty (Side A)</b>     | 4-96                  |             |            |
| <b>BBB – Type of connector (Side A)</b> | SC-SC/PC              |             |            |
|   | SCA                   |             |            |
|   | E2                    |             |            |
|   | E2A                   |             |            |
|   | LC                    |             |            |
|   | LCA                   |             |            |
|   | FC                    |             |            |
|   | FCA                   |             |            |
|   | ST                    |             |            |
| <b>Connectors qty (Side B)</b>          | 4-96                  |             |            |
| <b>BBB – Type of connector (Side B)</b> | SC-SC/PC              |             |            |
|   | SCA                   |             |            |
|   | E2                    |             |            |
|   | E2A                   |             |            |
|   | LC                    |             |            |
|   | LCA                   |             |            |
|   | FC                    |             |            |
|   | FCA                   |             |            |
|   | ST                    |             |            |
| <b>EE – Cable type</b>                  | 01                    | EXO-CO PE   |            |
|   | 02                    | EXO-CO LSZH |            |
|   | 03                    | EXO-CI PE   |            |
|   | 04                    | EXO-CI LSZH |            |
|   | 05                    | BDC-CO PE   |            |
|   | 06                    | BDC-CO LSZH |            |
|   | 07                    | BDC-CI PE   |            |
|   | 08                    | BDC-CI LSZH |            |
|   | 24                    | BURRY DAC   |            |
|   | 28                    | AERO DF 03  |            |
|   | 35                    | FTTA DAC    |            |
|   | <b>F – Fibre type</b> | A           | SMF G.652D |
|   |                       | B           | SMF G655   |
|   |                       | C           | SMF G656   |
|   |                       | D           | SMF G657A1 |
| E                                       |                       | SMF G657A2  |            |
| F                                       |                       | SMF G657B2  |            |
| G                                       |                       | SMF G657B3  |            |
| L                                       |                       | MMF OM4     |            |

|   |               |                |
|---|---------------|----------------|
| <b>XXXX.X Cable length</b>                | <b>XXXX.X</b> |                |
| <b>G – Stepping (Side A)</b>              | 0 –           | equal length   |
|   | 1 –           | single cascade |
|   | 2 –           | double cascade |
| <b>YYY – Fan-out length (Side A) [cm]</b> | <b>yyy</b>    |                |
| <b>H – Fan-out diameter (Side A)</b>      | 0 –           | 0.9 mm         |
|   | 1 –           | 1.8 mm         |
|   | 2 –           | 2.8 mm         |
| <b>I – Stepping (Side B)</b>              | 0 –           | equal length   |
|   | 1 –           | single cascade |
|   | 2 –           | double cascade |
| <b>ZZZ – Fan-out length (Side B) [cm]</b> | <b>zzz</b>    |                |
| <b>J – Fan-out diameter (Side B)</b>      | 0 –           | 0.9 mm         |
|   | 1 –           | 1.8 mm         |
|   | 2 –           | 2.8 mm         |

Maximal outputs length in a standard configuration: 200 cm, minimal: 10 cm; for other outputs length please contact with our sales department.

| AVAILABLE CASCADES    |   |
|-----------------------|---|
| <b>Singe cascade</b>  | Each furcation leg is shorter by 3 cm than a previous one     |
| <b>Double cascade</b> | Pair of furcation legs is shorter by 3 cm than a previous one |

## Example

PTF-**12****SCA**-**12****SCA**-**01****A**-**0100.0**-**01201**-**11200**

PTF pre-connectorized cable (EXO CO PE), SMF G.652D fibers, 100 m total length, pre-connectorized with 12xSC/APC connectors on both sides, Side A : equal length of all fan-out cables, fan-out length 120cm, diameter of each fan-out cable 1.8 mm, Side B: single cascade of fan-out, fan-out length 120 cm (of the longest cable), diameter of each fan-out cable 0.9 mm.

To order a non-standard option, please contact with our Sales Department.

# MTP® trunk/connecting cables

## Fiber identification and polarization classification:

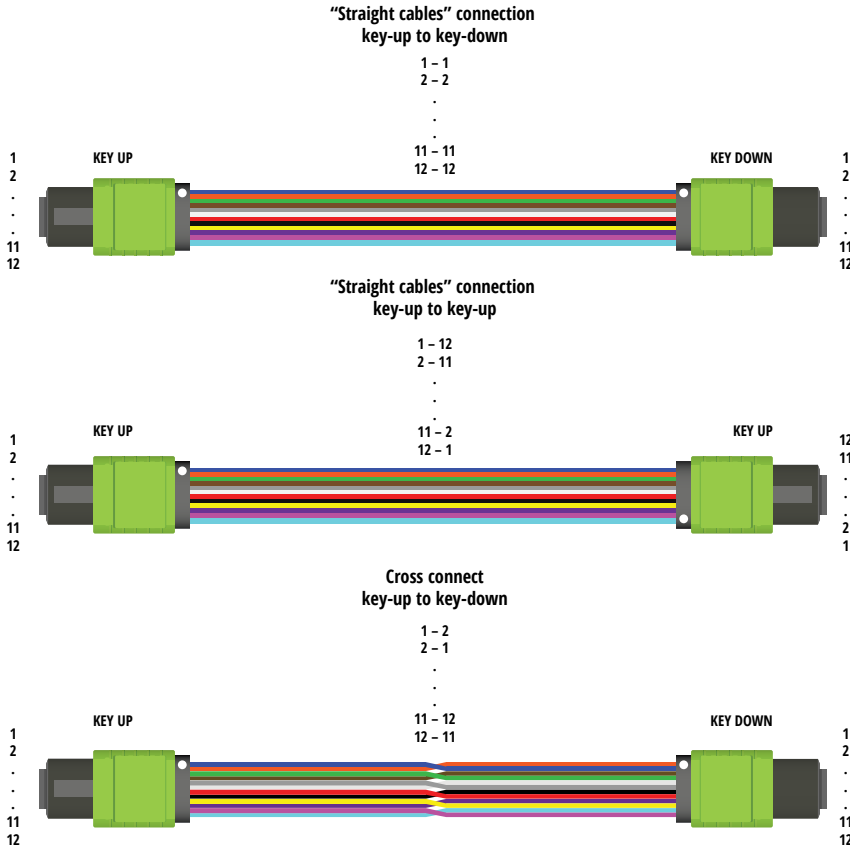

### Description

Fiber optic patchcords terminated with MTP® connectors are specifically designed for Data Center system. MTP® connectors, using the MT ferrule, can increase the density of 4 to 72x compared to traditional, single-fiber optic connectors. MTP® patchcords and pigtails are specifically designed to be used in both single- and multimode transmission. Modern and repeatable production process, detailed quality control, interferometric as well as IL & RL parameters control measurement make FIBRAIN patchcords and pigtails reliable elements of tracks and fiber optic networks. Connecting elements terminated with MTP® connectors are popular and willingly used solution for Data Center cabling, backbone networks and local broadcast of bandwidth 40/100 Gb /s bandwidth.

### Applications

- Telecommunication networks,
- Data Center SYSTEMS,
- FTtx, FTTD, FTTB, FTTH networks

### Features

- In accordance with IEC 61754-7, TIA/EIA 568-C,
- High quality and repeatability of transmission parameters,
- Connectors made of high quality plastics,
- MTP connectors compatible with MPO connectors,
- Good value for money, the best price-quality,
- High quality MT ferrule provides placing a lot of optical fibers in one connector.

## Ordering information

| Class  | Fiber qty | Connector               |                         | Boot type    | Cable diameter     | Length [m] | Cable type  | Fiber type | Polarization |
|--------|-----------|-------------------------|-------------------------|--------------|--------------------|------------|-------------|------------|--------------|
|        |           | A                       | B                       |              |                    |            |             |            |              |
| G-Gold | 12-12     | MTPA.F – MTP female APC | MTPA.F – MTP female APC | S - standard | R30 – round 3.0 mm | 001.0      | 1 – DC PRIM | A – G652D  | A            |
|        |           | MTPA.M – MTP male APC   | MTPA.M – MTP male APC   |              |                    |            |             | D – G657A1 | B            |
|        |           | MTP.F – MTP female      | MTP.F – MTP female      |              |                    |            |             | E – G657A2 | C            |
|        |           | MTP.M – MTP male        | MTP.M – MTP male        |              |                    |            |             | H – OM1    |              |
|        |           |                         |                         |              |                    |            |             | I – OM2    |              |
|        |           |                         |                         |              |                    |            |             | K – OM3    |              |
|        |           |                         |                         | L – OM4      |                    |            |             |            |              |

### TECHNICAL SPECIFICATIONS

| Parameter  | MTP APC SM | MM PC     |
|--|------------|-----------|
| Insertion Loss<br>IL <sub>MAX</sub> against MASTER<br>Acc. IEC 61300-3-4 | ≤ 0.40 dB  | ≤ 0.40 dB |
| Insertion Loss<br>IL <sub>TYP</sub> against MASTER<br>Acc. IEC 61300-3-4 | ≤ 0.20 dB  | ≤ 0.20 dB |
| Return Loss<br>Acc. IEC 61300-3-6  | ≥ 65 dB    | ≥ 35 dB   |

# MTP® fanouts direct split



## Technical specification

### Multi-fiber MTP connectors

| Parameter   | MTP APC SM | MM PC     |
|---|------------|-----------|
| Max. Insertion Loss<br>$I_{L_{MAX}}$<br>Acc. IEC 61300-3-4    | ≤ 0.40 dB  | ≤ 0.40 dB |
| Typical Insertion Loss<br>$I_{L_{TYP}}$<br>Acc. IEC 61300-3-4 | ≤ 0.20 dB  | ≤ 0.20 dB |
| Return Loss<br>RL<br>Acc. IEC 61300-3-6                       | ≥ 65 dB    | ≥ 35 dB   |

### Single-fiber standard optical connectors

| Parameter (connectors)  | SM PC     | SM APC    | MM        |
|---|-----------|-----------|-----------|
| Max. Insertion Loss<br>$I_{L_{MAX}}$<br>Acc. IEC 61300-3-4    | ≤ 0.17 dB | ≤ 0.20 dB | ≤ 0.20 dB |
| Typical Insertion Loss<br>$I_{L_{TYP}}$<br>Acc. IEC 61300-3-4 | ≤ 0.15 dB | ≤ 0.16 dB | ≤ 0.12 dB |
| Return Loss<br>RL<br>Acc. IEC 61300-3-6                       | ≥ 55 dB   | ≥ 65 dB   | ≥ 35 dB   |

## Fiber identification - fiber color (outer transparent tube)

| 1-12  | 1    | 2      | 3     | 4     | 5    | 6     | 7   | 8     | 9      | 10     | 11   | 12   |
|-------|------|--------|-------|-------|------|-------|-----|-------|--------|--------|------|------|
| Code  | ■    | ■      | ■     | ■     | ■    | ■     | ■   | ■     | ■      | ■      | ■    | ■    |
| Color | blue | orange | green | brown | grey | white | red | black | yellow | violet | pink | aqua |

## Ordering information

| Class  | Fiber qty | Connector                  |     | Boot type      | Cable diameter | Length [m] | Cable type        | Fiber      |
|--------|-----------|----------------------------|-----|----------------|----------------|------------|-------------------|------------|
|        |           | A                          | B   |                |                |            |                   |            |
| G-Gold | 12-12     | MTPA.F<br>– MTP female APC | SC  | S<br>-standard | 09 - 900µm     | 001.0      | DS – Direct Split | A – G652D  |
|        |           | MTPA.M<br>– MTP male APC   | SCA |                |                |            |                   | D – G657A1 |
|        |           | MTP.F<br>– MTP female      | LC  |                |                |            |                   | E – G657A2 |
|        |           | MTP.M<br>– MTP male        | LCA |                |                |            |                   | H – OM1    |
|        |           |                            | FC  |                |                |            |                   | I – OM2    |
|        |           |                            | FCA |                |                |            |                   | K – OM3    |
|        |           |                            | E2  |                |                |            |                   | L – OM4    |
|        |           |                            | E2A |                |                |            |                   |            |

### Description

→ FIBRAIN MTP® Fanouts of Direct Split type connect MTP® multi-fiber connectors with standard, single-fiber optic connectors. This solution is specifically designed to be used in singlemode and multimode transmission. Therefore, in our product portfolio, there is a wide range of fiber optic connectors. The side terminated with MTP® connectors includes male or female connectors- depending on customer's needs.

### Applications

- Telecommunication networks,
- Data Center SYSTEMS,
- FTTx, FTTD, FTTB, FTTH networks

### Features

- In accordance with IEC, TIA/EIA standards ,
- High quality and repeatability of transmission parameters,
- Connectors made of high quality plastics,
- Good value for money, the best price-quality ratio,
- High quality MT ferrule, provides placing a lot optical fibers in one connector.

**FIBER  
OPTIC**



**PATCH PANELS**

# FIBER OPTIC PATCH PANELS

Platform for fiber optic and copper solutions



**SOLID & RELIABLE  
CONSTRUCTION**



**HIGH DENSITY  
APPLICATION**

**HIGHEST DENSITY  
UP TO 96 FIBERS PER 1U**



**1U  
3U**

**1U-3U VERSIONS**



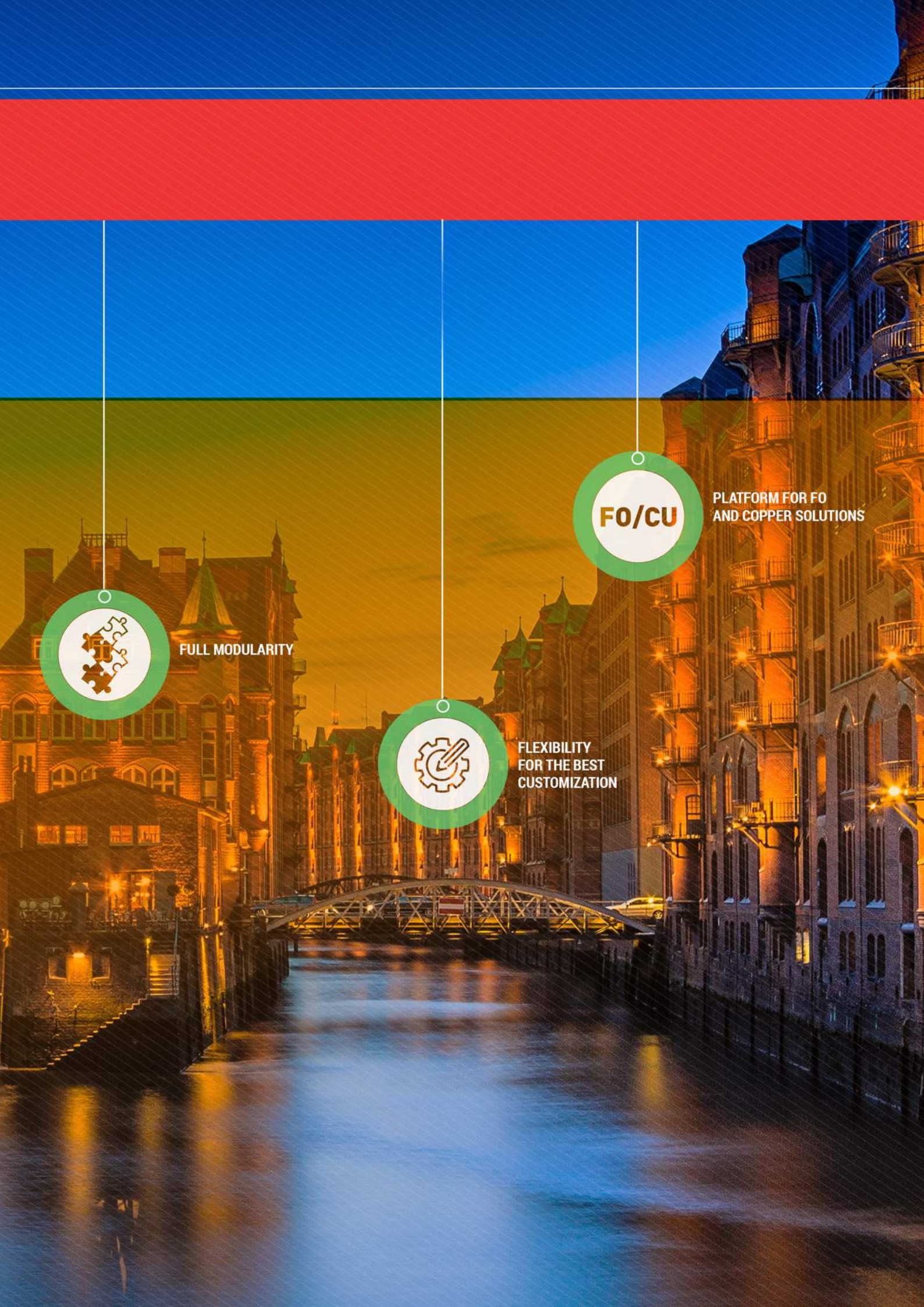

FULL MODULARITY



FLEXIBILITY  
FOR THE BEST  
CUSTOMIZATION



PLATFORM FOR FO  
AND COPPER SOLUTIONS

# PST-A1 Equipped Patch Panel



## TECHNICAL SPECIFICATIONS

|                               | PST-A1-01            | PST-A1-02            |
|-------------------------------|----------------------|----------------------|
| <b>Height</b>                 | 1U (44 mm)           | 2U (88 mm)           |
| <b>Width</b>                  | 19" (483 mm)         | 19" (483 mm)         |
| <b>Depth [mm]</b>             | 258                  | 258                  |
| <b>Max. cassette capacity</b> | 3                    | 6                    |
| <b>Casing material</b>        | Powder painted steel | Powder painted steel |

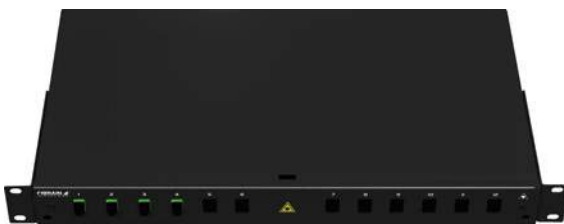
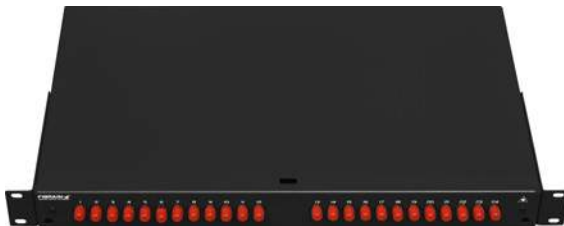

### Description

→ FIBRAIN telescopic fiber optic patch panel PST-A1 are specifically designed and tailored to meet our customers' needs. Main distribution areas where these panels can be applied are patching shelves and splicing shelves. Removable front panels facilitate installation of all standards of adapters, including hybrid combinations. Patch panels are made of grey RAL7035 powder-coated metal steel and are available in 1U and 2U options. Telescopic patch panels are available in black RAL7005 too. Panels on telescopic rails provide a full opening to mount cables easily. Cable entries are adjusted to mount PG13.5 - PG16 cable glands and preterminated multifiber cables (FIBRAIN multipatchcords solution). The interior design with handles facilitate proper management of fibers. Therefore, adjustable side handles provide the possibility to move the panel inside the cabinets. Our product portfolio offer includes a large variety of front plates, thus almost each standard of adapters can be easily mounted.

### Applications

- Fiber optics interchange points
- Distribution networks
- Server room

### Features

- Available in 1U and 2U
- Full opening on telescopic rails
- Cable entries in a back part of a panel
- Internal perforation to manage tubes or fibers
- Faceplates for mounting adapters without screws
- Optional front shelf to facilitate the management of patchcords
- Adjustable side handles
- Front plates can be optionally locked with a key
- High capacity
- Holder for the strength element of cable

# PST-A1 Equipped Patch Panel

## Ordering syntax

PST-A1-**AABBC**-**DDEFG**-**HHIJKLL**-**MN**-**OOOP**-**RS**

|                       |                     |                                   |                      |
|-----------------------|---------------------|-----------------------------------|----------------------|
| AA – Height           | <b>01 – 1U</b>      | grey RAL7035                      |                      |
|                       | <b>02 – 2U</b>      | grey RAL7035                      |                      |
|                       | <b>B1 – 1U</b>      | black RAL 9005                    |                      |
|                       | <b>B2 – 2U</b>      | black RAL 9005                    |                      |
| BB – Front plate type | <b>01 – FB2030</b>  | 12x ST,FC                         | Pannels<br><b>1U</b> |
|                       | <b>02 – FB2031</b>  | 12x SC SX, LC DX, E2000 SX        |                      |
|                       | <b>03 – FB2031B</b> | 12x SC SX, LC DX, E2000 SX, black |                      |
|                       | <b>04 – FB2032</b>  | 12x SC DX, LC 4X                  |                      |
|                       | <b>05 – FB2032B</b> | 12x SC DX, LC 4X, black           |                      |
|                       | <b>06 – FB2033</b>  | 24x ST, FC                        |                      |
|                       | <b>07 – FB2034</b>  | 24x SC SX,LC DX, E2000 SX         |                      |
|                       | <b>08 – FB2034B</b> | 24x SC SX,LC DX, E2000 SX, black  |                      |
|                       | <b>09 – FB2035</b>  | 24x SC DX, LC 4X                  | Pannels<br><b>2U</b> |
|                       | <b>10 – FB2035B</b> | 24x SC DX, LC 4X, black           |                      |
|                       | <b>11 – FB2043</b>  | 48x ST, FC                        |                      |
|                       | <b>12 – FB2044</b>  | 48x SC SX, LC DX, E2000 SX        |                      |
|                       | <b>13 – FB2045</b>  | 48x SC DX, LC 4X                  |                      |
|                       | <b>14 – FB2046</b>  | 72x SC SX, LC DX, E2000 SX        |                      |
|                       | <b>15 – FB2046B</b> | 72x SC SX, LC DX, E2000 SX, black |                      |
|                       | <b>16 – FB2047</b>  | 72x ST, FC                        |                      |
| C – Lock              | <b>K –</b>          | plate with lock                   |                      |
|                       | <b>0 –</b>          | plate without lock                |                      |

|                              |   |
|------------------------------|---|
| DD – Adapters qty            | <b>6,12,24,36,48,72</b>                                   |
| E – Adapter class            | <b>0 –</b> none   |
|                              | <b>1 –</b> Standard One-Piece (or standard E2000, FC, ST) |
|                              | <b>2 –</b> Premium Super One-Piece                        |
|                              | <b>3 –</b> Premium One-Piece with internal shutter        |
|                              | <b>4 –</b> Premium Super One-Piece with internal shutter  |
| <b>5 –</b> Premium (@FC, ST) |   |
| F – Adapter type             | <b>0 –</b> none   |
|                              | <b>1 –</b> SC   |
|                              | <b>2 –</b> SCA  |
|                              | <b>3 –</b> E2000  |
|                              | <b>4 –</b> E2000 APC                                      |
|                              | <b>5 –</b> LC   |
|                              | <b>6 –</b> LCA  |
|                              | <b>7 –</b> FC   |
|                              | <b>8 –</b> FCA  |
| <b>9 –</b> ST                |   |
| G – Transmission             | <b>1 –</b> SM   |
|                              | <b>2 –</b> MM (beige @SC/LC, black @E2000)                |
|                              | <b>3 –</b> MM OM3 (aqua @SC/LC)                           |
|                              | <b>4 –</b> MM OM4 (violet @SC/LC)                         |

|                    |  |
|--------------------|--|
| HH – Pigtaills qty | <b>6,12,24,36,48,72,96</b>                                   |
| I – Fiber type     | <b>A –</b> G.652D  |
|                    | <b>B –</b> G.655   |
|                    | <b>C –</b> G.656   |
|                    | <b>D –</b> G.657A1   |
|                    | <b>E –</b> G.657A2   |
|                    | <b>F –</b> G.657B2   |
|                    | <b>G –</b> G.657B3   |
|                    | <b>H –</b> MM OM1  |
|                    | <b>I –</b> MM OM2  |
|                    | <b>K –</b> MM OM3  |
|                    | <b>L –</b> MM OM4  |
|                    | JJ – Connector type  |
| <b>02 –</b> SCA    |  |
| <b>03 –</b> LC     |  |
| <b>04 –</b> LCA    |  |
| <b>05 –</b> FC     |  |
| <b>06 –</b> FCA    |  |
| <b>07 –</b> E2     |  |
| <b>08 –</b> E2A    |  |
| <b>09 –</b> ST     |  |
| <b>S –</b> Silver  |  |
| K – Pigtail grade  | <b>G –</b> Gold  |
|                    | <b>T –</b> Titanium  |
|                    | <b>LL – Color identification</b>                             |
| <b>01 –</b>        | for pigtaills with yellow 0.9 mm buffer                      |
| <b>02 –</b>        | for pigtaills with orange 0.9 mm buffer                      |
| <b>03 –</b>        | T TELECOM (acc. to IEC60304)                                 |
| <b>04 –</b>        | T1 TELECOM (acc. to 60304/tab. 3 & ZN-11/TPSA-005-02)        |
| <b>05 –</b>        | T2 TELECOM (acc. to EIA 598A)                                |
| <b>06 –</b>        | D DATACOM (acc. to DIN VDE 0888 & IEC 60304)                 |
| <b>07 –</b>        | D1 DATACOM (acc. to IEC 60304, TIA/EIA 598-A, TIA/EIA 598-C) |

|                         |                      |
|-------------------------|----------------------|
| M – Splice trays number | <b>1-6</b>           |
| N – Splice trays type   | <b>1 –</b> SCM-A-12H |
|                         | <b>2 –</b> SCM-A-24H |

|                  |                         |
|------------------|-------------------------|
| OOO – Sleeve qty | <b>6,12,24,36,48,72</b> |
| P – Sleeve type  | <b>1 –</b> 45 mm        |

|                      |                   |
|----------------------|-------------------|
| R – Cable gland qty  | <b>1-4</b>        |
| S – Cable gland type | <b>1 –</b> PG13.5 |
|                      | <b>2 –</b> PG16   |

## Example

PST-A1-**01020**-**12121**-**12D02G01**-**11**-**0121**-**11** FIBRAIN telescopic fiber optic patch panel, 1U, equipped with front plate FB2031 (12x SC SX), Standard SM One-Piece SC APC adapters, 12 SM pigtaills Gold Grade SC APC, 2 m long, yellow jacket, one 12F splice tray with 12F splice magazine, front plate without the lock mechanism, equipped with PG13,5 cable gland, grey color of body

To order a non-standard option, please contact with our Sales Department.

# PST-C1 Telescopic Fiber Optic Patch Panel



## TECHNICAL SPECIFICATIONS

|                               |                      |
|-------------------------------|----------------------|
| <b>Height</b>                 | 1U (44 mm)           |
| <b>Width</b>                  | 19" (483 mm)         |
| <b>Depth [mm]</b>             | 256                  |
| <b>Max. cassette capacity</b> | 2                    |
| <b>Casing material</b>        | Powder painted steel |
| <b>Front flap</b>             | Anodized aluminium   |



### Description

- FIBRAIN telescopic patch panel offers excellent flexibility during mounting and installation. Mainly used for distribution – patching or splicing shelves. Constructed of high quality material ensuring very easy installation and maintenance.
- Removable front panels facilitates installation of all kinds of adapters, including the creation of hybrid combinations.
- Patch panels are made of powder-coated steel as standard in black and available in 1U option. The movable front flap is made of anodized aluminum which protects pigtailed against accidental damage. Panels mounted on telescopic rails provide a full extension for easy cable mounting. Cable entry adjusted to mount PG16 cable glands and terminated FIBRAIN multipatchcords solution. The interior design with handles with handles facilitate the proper management of fiber. Therefore, adjustable side handles provide the possibility to move the panel inside the cabinets.

### Applications

- Fiber optics interchange points
- Distribution networks
- Server room

### Features

- 1U
- Full extension on telescopic rails
- Cable entry shifted back in a patch panel
- Handles to manage tubes or fibers
- Removable faceplates for mounting adapters without screws
- Front shelf for patchcords management
- Adjustable side handles
- High capacity
- Moveable front flap, which is a patch cord protection from accidental damage

# PST-C1 Telescopic Fiber Optic Patch Panel

## Ordering syntax

PST-C1-AA-BCC-DDEFG-HHIJJKK-LM-NNO-PR

|                          |   |
|--------------------------|---|
| <b>AA – Height</b>       | <b>01 – 1U</b>  |
| <b>B – Panels qty</b>    | <b>1 –</b> 1x12 ports front panel                         |
|                          | <b>2 –</b> 2x12 ports front panel                         |
| <b>CC – Panel type</b>   | <b>01 –</b> SC SX/LC DX                                   |
|                          | <b>02 –</b> FC/ST   |
| <b>DD – Adapters</b>     | <b>6,12,24,36,48,72</b>                                   |
| <b>E – Adapter class</b> | <b>1 –</b> Standard One-Piece (or standard E2000, FC, ST) |
|                          | <b>2 –</b> Premium Super One-Piece                        |
|                          | <b>3 –</b> Premium One-Piece with internal shutter        |
|                          | <b>4 –</b> Premium Super One-Piece with internal shutter  |
|                          | <b>5 –</b> Premium (@FC, ST)                              |
| <b>F – Adapter type</b>  | <b>1 –</b> SC   |
|                          | <b>2 –</b> SCA  |
|                          | <b>3 –</b> E2000  |
|                          | <b>4 –</b> E2000 APC                                      |
|                          | <b>5 –</b> LC   |
|                          | <b>6 –</b> LCA  |
|                          | <b>7 –</b> FC   |
|                          | <b>8 –</b> FCA  |
|                          | <b>9 –</b> ST   |
| <b>G – Transmission</b>  | <b>1 –</b> SM   |
|                          | <b>2 –</b> MM (beige @SC/LC, black @E2000)                |
|                          | <b>3 –</b> MM OM3 (aqua @SC/LC)                           |
|                          | <b>4 –</b> MM OM4 (violet @SC/LC)                         |

|  |  |
|--|--|
| <b>HH – Pigtailed qty</b>              | <b>6,12,24,36,48</b>   |
| <b>I – Fiber type</b>                  | <b>A –</b> G.652D  |
|  | <b>B –</b> G.655   |
|  | <b>C –</b> G.656   |
|  | <b>D –</b> G.657A1   |
|  | <b>E –</b> G.657A2   |
|  | <b>F –</b> G.657B2   |
|  | <b>G –</b> G.657B3   |
|  | <b>H –</b> MM OM1  |
|  | <b>I –</b> MM OM2  |
|  | <b>K –</b> MM OM3  |
| <b>L –</b> MM OM4                      |  |
| <b>JJ – Connector type</b>             | <b>01 –</b> SC   |
|  | <b>02 –</b> SCA  |
|  | <b>03 –</b> LC   |
|  | <b>04 –</b> LCA  |
|  | <b>05 –</b> FC   |
|  | <b>06 –</b> FCA  |
|  | <b>07 –</b> E2   |
|  | <b>08 –</b> E2A  |
|  | <b>09 –</b> ST   |
| <b>KK – Color identification</b>       | <b>01 –</b> for pigtails with yellow 0.9 mm buffer                       |
|  | <b>02 –</b> for pigtails with orange 0.9 mm buffer                       |
|  | <b>03 –</b> T TELECOM (acc. to IEC60304)                                 |
|  | <b>04 –</b> T1 TELECOM (acc. to 60304/tab. 3 & ZN-11/TPSA-005-02)        |
|  | <b>05 –</b> T2 TELECOM (acc. to EIA 598A)                                |
|  | <b>06 –</b> D DATACOM (acc. to DIN VDE 0888 & IEC 60304)                 |
|  | <b>07 –</b> D1 DATACOM (acc. to IEC 60304, TIA/EIA 598-A, TIA/EIA 598-C) |
| <b>L – Splice trays number</b>         | <b>1-6</b>   |
| <b>M – Splice trays type</b>           | <b>1 –</b> SCM-A-12H   |
|  | <b>2 –</b> SCM-A-24H   |
| <b>NN – Heat shrink protection qty</b> | <b>6,12,24,36,48,72</b>  |
| <b>O – Heat shrink protection type</b> | <b>1 –</b> 45 mm   |
| <b>P – Cable gland qty</b>             | <b>1-4</b>   |
| <b>R – Cable gland type</b>            | <b>1 –</b> PG13,5  |
|  | <b>2 –</b> PG16  |

## Example

PST-C1-01-101-12221-12A0201-11-112-12

FIBRAIN fiber optic patch panel, 1U, equipped with 1 front plate for 12x SC SX, Premium Super One-Piece SC APC adapters, 12 pigtails with SC APC connectors in Gold Grade with 2 m length in yellow buffer, G.652D fiber, 1xsplice tray with 12F splice magazine, equipped with 12 heat shrink protections (45mm), 1 PG16 cable gland.

To order a non-standard option, please contact with our Sales Department.

# PSR-A0 Pivot Swivel Panel



## TECHNICAL SPECIFICATIONS

|                                  | PSR-A0-01            | PSR-A0-02 |
|----------------------------------|----------------------|-----------|
| Height                           | 1U                   | 2U        |
| Maximal fiber qty                | 48                   | 96        |
| Maximal splice qty               | 48                   | 96        |
| Maximal splice cassette qty      | 2                    | 4         |
| Maximal line cable diameter [mm] | 12                   |           |
| Depth [mm]                       | 315                  |           |
| Operating temperature            | -20°C – +50°C        |           |
| Casing material                  | Powder painted steel |           |

## Ordering information

| Code                             | Description   |
|----------------------------------|---|
| PSR-A0-01-R-00-00000-0000000-000 | FIBRAIN 1U rotational patch panel, right side A0 version, non-equipped; grey (RAL7035)        |
| PSR-A0-02-R-00-00000-0000000-000 | FIBRAIN 2U rotational patch panel, right side A0 version, non-equipped; grey (RAL7035)        |
| PSR-A0-B1-R-00-00000-0000000-000 | FIBRAIN 1U rotational patch panel, right side A0 version, non-equipped; black (RAL 9005)      |
| PSR-A0-B2-R-00-00000-0000000-000 | FIBRAIN fiber optic patch panel, 1U, equipped with 1 front plate for 12x SC SX, Premium Super |

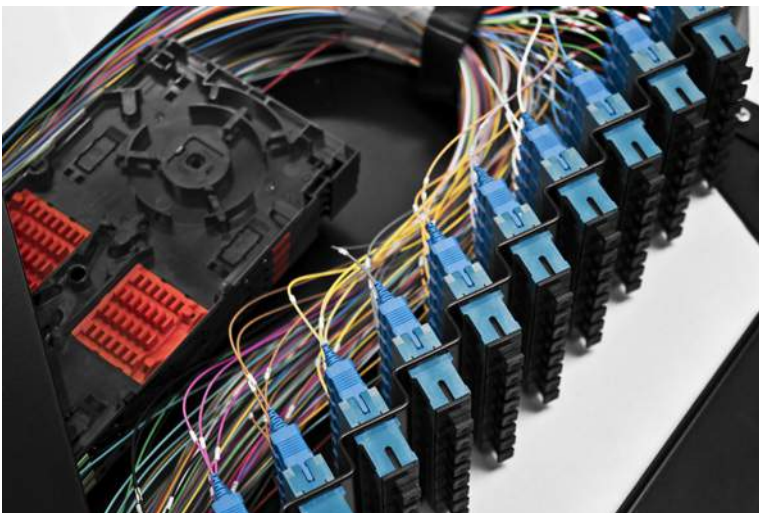

## Fiber Optic Patch Panels

### Description

- Rotational patch panel PSR-A0 type, in 1U or 2U version, is basic mounting block for fiber management system, in patch panel holder. Available in version routing on the left or right side, so it offers well accessibility to trays and patching cords on both sides. It minimizes and protect patch cords cables movement inside patch panels.
- Patch panel PSR-A0 offers trays patch cords in SC simplex standard for 48 fields in 1U version or 96 fields in 2U, available installation into 2 or 4 splice trays for 24 solders. Tray patch cords allow mount connector for 25 degree angle from the diagonal plane.

### Applications

- Fiber optics interchanges points
- Distribution network
- Server room

### Features

- Metal casing- anticorrosive protected
- Cable bushing in back parts of line cables
- Cable bushing in the front parts of patchcords
- Patch panel installation on a back or front rack profile
- Capacity up to
- 48 fibers in 1U
- 96 fibers in 2U
- Cable bushing in patch panel are equipped in brush guards
- Panel available rotating to left or right side of patch panel (depends on version)
- Offers separated canal for patch cord cables
- Possibilities termination line and local cables on aside or back of patch panel
- Hinged flap of patch panel, protects patch cords against damages

# PSR-A0 Pivot Swivel Panel

## Ordering syntax

PSR-A0-XX-A-BC-DDEFG-HHIJKLL-MMO

|                                    |                  |   |
|------------------------------------|------------------|---|
| <b>XX – Height variant</b>         | <b>01</b>        | 1U (grey RAL 7035)                            |
|                                    | <b>02</b>        | 2U (grey RAL 7035)                            |
|                                    | <b>B1</b>        | 1U (black RAL 9005)                           |
|                                    | <b>B2</b>        | 2U (black RAL 9005)                           |
| <b>A – Shelf opening direction</b> | <b>R</b>         | right   |
|                                    | <b>L</b>         | left  |
| <b>B – Cassette qty</b>            | <b>0-4</b>       |   |
| <b>C – Cassette type</b>           | <b>1</b>         | SCM-A-24H                                     |
| <b>DD – Adapters qty:</b>          | <b>1-48</b> (1U) | Unused ports are blinded                      |
|                                    | <b>1-96</b> (2U) |   |
| <b>E – Adapter class:</b>          | <b>1</b>         | Standard One-Piece                            |
|                                    | <b>2</b>         | Premium One-Piece with internal shutter       |
|                                    | <b>3</b>         | Premium Super One-Piece                       |
|                                    | <b>4</b>         | Premium Super One-Piece with internal shutter |
| <b>F – Adapter type:</b>           | <b>1</b>         | SC  |
|                                    | <b>2</b>         | SCA   |
|                                    | <b>3</b>         | E2  |
|                                    | <b>4</b>         | E2A   |
| <b>G – Transmission</b>            | <b>1</b>         | SM  |
|                                    | <b>2</b>         | MM (beige @SC, black @E2000)                  |
|                                    | <b>3</b>         | MM OM3 (aqua @SC)                             |
|                                    | <b>4</b>         | MM OM4 (violet @SC)                           |

|   |   |  |
|---|---|--|
| <b>HH – Pigtailed qty</b>               | <b>0-96</b>                             |  |
| <b>I – Fiber type</b>                   | <b>A</b>                                | G.652D   |
|   | <b>B</b>                                | G.655  |
|   | <b>C</b>                                | G.656  |
|   | <b>D</b>                                | G.657A1  |
|   | <b>E</b>                                | G.657A2  |
|   | <b>F</b>                                | G.657B2  |
|   | <b>G</b>                                | G.657B3  |
|   | <b>H</b>                                | MM OM1   |
|   | <b>I</b>                                | MM OM2   |
|   | <b>K</b>                                | MM OM3   |
|   | <b>L</b>                                | MM OM4   |
|   | <b>J – Connector type</b>               | <b>1</b>   |
| <b>2</b>                                |   | SCA  |
| <b>3</b>                                |   | E2   |
| <b>4</b>                                |   | E2A  |
| <b>K – Pigtailed grade</b>              | <b>S</b>                                | Silver   |
|   | <b>G</b>                                | Gold   |
|   | <b>T</b>                                | Titanium   |
|   | <b>01</b>                               | for pigtailed with yellow 0.9 mm buffer                      |
| <b>LL – Color identification</b>        | <b>02</b>                               | for pigtailed with orange 0.9 mm buffer                      |
|   | <b>03</b>                               | T TELECOM (acc. to IEC60304)                                 |
|   | <b>04</b>                               | T1 TELECOM (acc. to 60304/tab. 3 & ZN-11/TPSA-005-02)        |
|   | <b>05</b>                               | T2 TELECOM (acc. to EIA 598A)                                |
|   | <b>06</b>                               | D DATACOM (acc. to DIN VDE 0888 & IEC 60304)                 |
|   | <b>07</b>                               | D1 DATACOM (acc. to IEC 60304, TIA/EIA 598-A, TIA/EIA 598-C) |
|   | <b>MM – Heat shrink protections qty</b> | <b>0-96</b>  |
| <b>O – Heat shrink protections type</b> | <b>1</b>                                | 45 mm  |

## Example

PSR-A0-02-R-41-96311-96A1G01-961 FIBRAIN rotational patch panel with side access, right, equipped with 4 splice cassettes for 24 splice protectors, 96 Gold grade pitails terminated with SC PC connectors, 2m length on G.652D fiber, 96 Premium Super One-Piece SC PC adapters and 96 splice protectors 45 mm.

To order a non-standard option, please contact with our Sales Department.

# PS-19-1-3PS Modular Fiber Optic Patch Panel, 1U, chassis



| PS-19-3-3PS CHASSIS |                |
|---------------------|----------------|
| Height              | 3U (133.35 mm) |
| Width [mm]          | 19" (484.6 mm) |
| Depth [mm]          | 255            |
| Frame material      | aluminium      |
| PS-01-XX MODULE     |                |
| Length [mm]         | 220            |
| Width [mm]          | 129            |
| Depth [mm]          | 35             |
| PS-M1-XX MODULE     |                |
| Length [mm]         | 220            |
| Width [mm]          | 129            |
| Depth [mm]          | 35             |



**Description**

- FIBRAIN 1U patch panels accommodate up to 36/72 fibers within space of 1U. Smart design allows easy and time saving installation and operation. Chassis is equipped with 3 slots enabling installation of 3 FO cassettes up to 12/24 fibers each. Special openings at the rear part of the chassis allows for FO cable fixation by strain relief
- Wide range of FO cassettes equipped with various kind of MM and SM adapters, pigtails or preterminated MTP/MPO solution (Direct Split)

**Applications**

- Telecommunication server rooms
- FTTH networks
- Metro networks
- Structural cabling systems
- Data Center systems

**Features**

- Capacity up to 36/72 fibers in 1U
- Lightweight and strong aluminium construction
- Modules ready to be mounted
- Facilitated mounting of fiber optic cable's tube
- Clear management of fiber optic

## Ordering information

| Code        | Description   |
|-------------|---|
| PS-19-1-3PS | 1U Patch panel chassis with 3 slots for FO cassettes PS-01, PS-M1 types |

## Accessories

See page 140



# PS-19-3-0.PRO Modular Fiber Optic Patch Panel, 3U, chassis

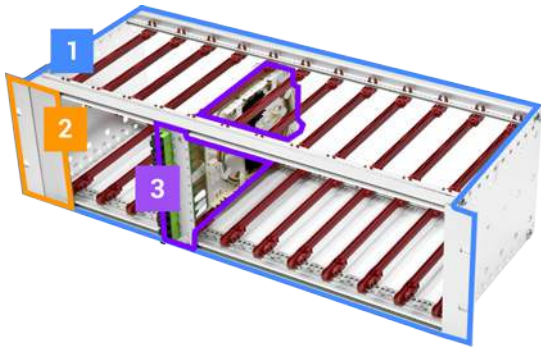

1. Chassis (frame)
2. Blind faceplate for unused ports
3. Matching cassettes for 3U patch panel

| PS-19-3-0.PRO CHASSIS |                |
|-----------------------|----------------|
| Height                | 3U (133.35 mm) |
| Width [mm]            | 436 (19")      |
| Depth [mm]            | 160            |
| Frame material        | aluminium      |
| Sliders material      | ABS            |
| PS-01-XX MODULE       |                |
| Length [mm]           | 220            |
| Width [mm]            | 129            |
| Depth [mm]            | 35             |
| PS-M1-XX MODULE       |                |
| Length [mm]           | 220            |
| Width [mm]            | 129            |
| Depth [mm]            | 35             |



## Description

- FIBRAIN 3U modular patch panels are solution facilitating termination up to 144/288 fibers in signal distribution points as well in server rooms. Smart design allows easy and time-saving way of installation and mounting of fiber optic cables. Main elements of this solution is frame of modular patch panel (chassis) and equipped 3U modular patch panel. Complete solution also offers patchcords management shelf, tubes and patchcords reserve shelf as well as fiber optic cables tubes separators.
- Additionally 3U modular patch panels can be provide with single modules equipped with MTP®/MPO Direct Split, which is perfect solution for Data Center application. Direct split allows to connect MTP multi-fiber connectors with standard, single-fiber optic connectors.

## Applications

- Telecommunication server rooms
- FTTH networks
- Metro networks
- Structural cabling systems
- Data Center systems

## Features

- Capacity up to 144/288 fibers in 3U
- Lightweight and strong aluminium construction
- Modules ready to be mounted
- Facilitated mounting of fiber optic cable's tube
- Clear management of fiber optic

## Ordering information

| Product                           | Reference number  |
|-----------------------------------|---|
| Chassis – patch panel frame       | PS-19-3-0.PRO   |
| Matching cassettes                | PS-01-xx & PS-M1-xx   |
| Blind faceplate for unused ports  | PS-00-P   |
| Patchcords reserve shelf          | PS-19-1-PAT (grey RAL 7035)<br>PS-19-1-PAT-B (black RAL 9005) |
| Tubes reserve shelf               | PS-19-1-TUB   |
| Patchcords management shelf       | PS-ORG-1-PP   |
| Fiber optic cables tube separator | RT-01-xx, see page 140  |

# PS-01 FO cassettes for modular patch panels 1U/3U, splice

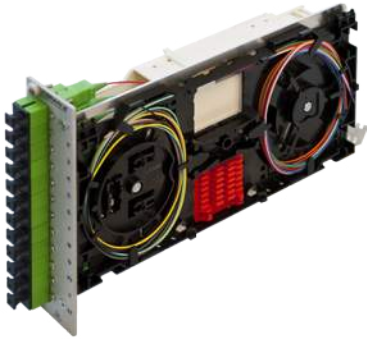

### DIMENSIONS

|             |     |
|-------------|-----|
| Length [mm] | 220 |
| Width [mm]  | 129 |
| Height [mm] | 35  |

### Front plates variants

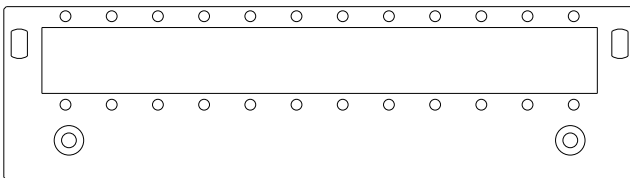

12xSC SX / E2000™ SX 6x LC DX (+6 blind covers)

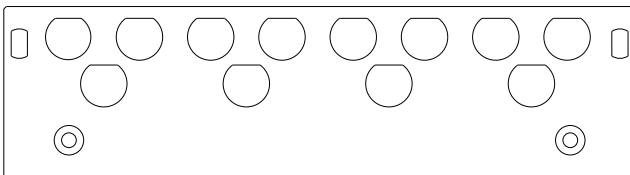

12xFC SX / ST SX

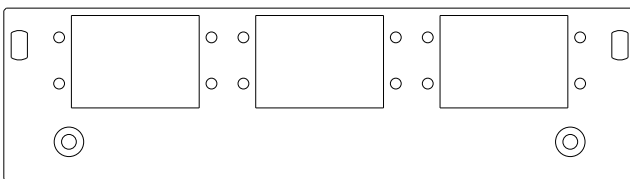

6 x LC 4X (LC quad)

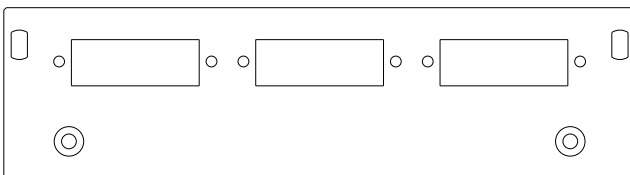

3 x LC 4X (LC quad)

### Ordering information

| Code        | Description   |
|-------------|---|
| PS-19-1-3PS | 1U Patch panel chassis with 3 slots for FO cassettes PS-01, PS-M1 types |

### Description

→ FIBRAIN PS-01 FO cassettes fits to FIBRAIN 1U/3U platforms (PS-19-1 & PS-19-e patch panels). They enables termination of max. 12/24 fibers. Cassette is equipped with a splice tray, splice magazines and heat shrink protections to store pigtails and protect fiber optic connections. It is factory equipped with adapters and pigtails of wide range of connectors type including SC/E2000/LC/FC/ST.

### Applications

- Nodal points of fiber optic networks
- Distribution points of fiber optic networks
- Server rooms

### Features

- Capacity up to 12/24 splices
- Modules ready to be mounted
- Fiber optic splice cassette made of ABS
- Facilitated identification and work due to 12 colours of pigtails
- Possibility to install fusion and mechanical splices in a fiber optic cassette
- Wide range of fiber optic adapters available

# PS-01 FO cassettes for modular patch panels 1U/3U, splice

## Ordering syntax

PS-01-**A**-**B**-**CCDEEF**-**GGHII**-**JJK**

|                   |                      |  |
|-------------------|----------------------|--|
| A – Fiber type    | <b>A</b>             | SMF 652D   |
|                   | <b>B</b>             | SMF 655  |
|                   | <b>D</b>             | SMF 657A1  |
|                   | <b>E</b>             | SMF 657A2  |
|                   | <b>F</b>             | SMF 657A3  |
|                   | <b>G</b>             | SMF 657B3  |
|                   | <b>H</b>             | MM OM1   |
|                   | <b>I</b>             | MM OM2   |
|                   | <b>K</b>             | MM OM3   |
|                   | <b>L</b>             | MM OM4   |
| B – Cassette type | <b>1</b>             | <b>SCM-A-12H</b>   |
|                   | <b>2</b>             | <b>FB7401PP</b> (in case of use FB7401PP module size: 211x129x35.2 (Length x Width x Depth)) |
|                   | <b>3</b>             | <b>SCM-A-24H</b>   |
| CC – Adapters qty | <b>3-12</b> (single) |  |
| D – Adapter class | <b>1</b>             | Standard One-Piece (@E2000, FC, ST)  |
|                   | <b>1T</b>            | Standard One-Piece with transparent cap (only for SC APC)                                    |
|                   | <b>2</b>             | Premium One-Piece with internal shutter  |
|                   | <b>3</b>             | Premium Super-One Piece with internal shutter  |
| EE – Adapter type | <b>01</b>            | SC SX  |
|                   | <b>02</b>            | SCA SX   |
|                   | <b>03</b>            | E2 SX  |
|                   | <b>04</b>            | E2A SX   |
|                   | <b>05</b>            | LC 4X  |
|                   | <b>06</b>            | LCA 4X   |
|                   | <b>07</b>            | FC SX  |
|                   | <b>08</b>            | FCA SX   |
|                   | <b>09</b>            | ST SX  |

|                           |                |  |
|---------------------------|----------------|--|
| F – Transmission          | <b>1</b>       | SM   |
|                           | <b>2</b>       | MM (beige @SC/LC, black @E2000)                              |
|                           | <b>3</b>       | MM OM3 (aqua @SC/LC)   |
|                           | <b>4</b>       | MM OM4 (violet @SC/LC)                                       |
| GG – Pigtailed qty        | <b>12-24</b>   |  |
| H – Pigtail grade         | <b>S</b>       | Silver   |
|                           | <b>G</b>       | Gold   |
|                           | <b>T</b>       | Titanium   |
| II – Color identification | <b>01</b>      | for pigtails with yellow 0.9 mm buffer                       |
|                           | <b>02</b>      | for pigtails with orange 0.9 mm buffer                       |
|                           | <b>03</b>      | T TELECOM (acc. to IEC60304)                                 |
|                           | <b>04</b>      | T1 TELECOM (acc. to 60304/tab. 3 & ZN-11/TPSA-005-02)        |
|                           | <b>05</b>      | T2 TELECOM (acc. to EIA 598A)                                |
|                           | <b>06</b>      | D DATACOM (acc. to DIN VDE 0888 & IEC 60304)                 |
|                           | <b>07</b>      | D1 DATACOM (acc. to IEC 60304, TIA/EIA 598-A, TIA/EIA 598-C) |
| JJ – Splice protector qty | <b>12-24</b>   |  |
| K – Sleeve type           | <b>1-45 mm</b> |  |

## Example

PS-01-**A**-**1**-**121021**-**12G01**-**121**

FIBRAIN 3U patch panel module with pigtail reserve cassette, single, equipped with 12 SC APC Standard One-Piece adapters, 12 SC APC Gold Grade pigtails length: 2 m, 1 splice cassette for up to 12 sleeves and 12 splice protectors 45 mm

To order a non-standard option, please contact with our Sales Department.

# PS-M1 FO cassettes for modular patch panels 1U/3U, MPO/MTP

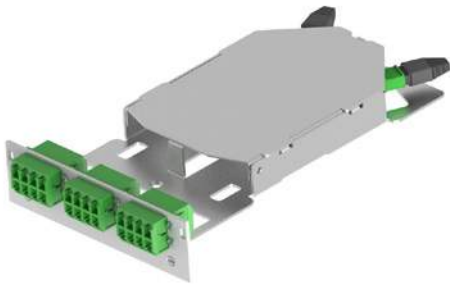

| DIMENSIONS  |     |
|-------------|-----|
| Length [mm] | 220 |
| Width [mm]  | 129 |
| Height [mm] | 35  |

## ■ Front plates variants

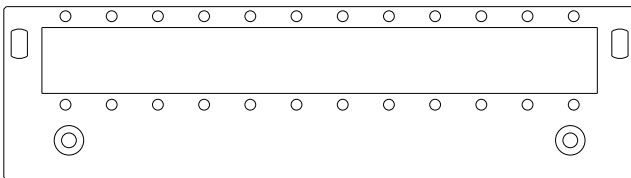

12xSC SX / E2000™ SX 6x LC DX (+6 blind covers)

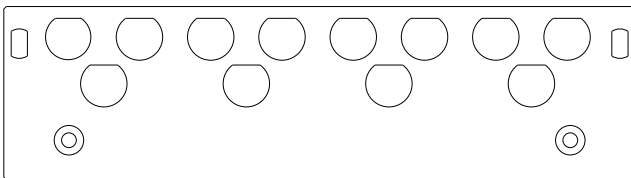

12xFC SX / ST SX

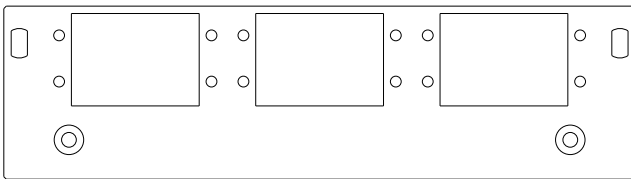

6 x LC 4X (LC quad)

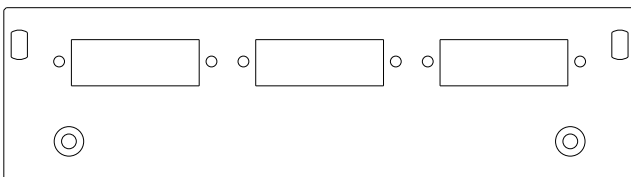

3 x LC 4X (LC quad)

### Description

- FIBRAIN PS-01 FO cassettes fits to FIBRAIN 1U/3U platforms (PS-19-1 & PS-19-e patch panels). They enables termination of max. 12/24 fibers. Cassette is equipped with a splice tray, splice magazines and heat shrink protections to store pigtails and protect fiber optic connections. It is factory equipped with adapters and pigtails of wide range of connectors type including SC/E2000/LC/FC/ST.

### Applications

- Nodal points of fiber optic networks
- Distribution points of fiber optic networks
- Server rooms

### Features

- Capacity up to 12/24 splices
- Plug & Play solution
- Fiber optic splice cassette made of ABS
- Wide range of fiber optic adapters available

# PS-M1 FO cassettes for modular patch panels 1U/3U, MPO/MTP

## Ordering syntax

PS-M1-**A**-**B**-**C****DE****FG**-**I****J****K****L**-**M****N**

|                                    |          |   |
|------------------------------------|----------|---|
| <b>A – Fiber type</b>              | <b>A</b> | SMF 652D  |
|                                    | <b>B</b> | SMF 655   |
|                                    | <b>D</b> | SMF 657A1   |
|                                    | <b>E</b> | SMF 657A2   |
|                                    | <b>F</b> | SMF 657A3   |
|                                    | <b>G</b> | SMF 657B3   |
|                                    | <b>H</b> | MM OM1  |
|                                    | <b>I</b> | MM OM2  |
|                                    | <b>K</b> | MM OM3  |
|                                    | <b>L</b> | MM OM4  |
| <b>B – Front panel type</b>        | <b>1</b> | 12x SC SX/12x E2000 SX/6x LC DX (+ 6 blind covers between LC DX adapters) |
|                                    | <b>2</b> | 12x ST/FC   |
|                                    | <b>3</b> | 6x LC 4X (6x LC QUAD)   |
|                                    | <b>4</b> | 3x LC 4X (3x LC QUAD)   |
| <b>C – Direct Split qty</b>        | <b>1</b> | 1 x DS in the module  |
|                                    | <b>2</b> | 2 x DS in the module  |
| <b>D – Direct Split type</b>       | <b>1</b> | 1x12  |
|                                    | <b>2</b> | 1x24  |
| <b>E – Connectors Grade</b>        | <b>G</b> | Gold MTP®/MPO & Gold for single-fiber connectors                          |
|                                    | <b>T</b> | Titanium MTP®/MPO & Titanium for single-fiber connectors                  |
| <b>F – Connector type MTP®/MPO</b> | <b>1</b> | MTP female APC  |
|                                    | <b>2</b> | MTP male APC  |
|                                    | <b>3</b> | MTP female MM   |
|                                    | <b>4</b> | MTP male MM   |

|  |             |   |
|--|-------------|---|
| <b>GG – Single-fiber connectors type</b> | <b>01</b>   | SC  |
|  | <b>02</b>   | SC APC  |
|  | <b>03</b>   | LC  |
|  | <b>04</b>   | LC APC  |
|  | <b>05</b>   | FC  |
|  | <b>06</b>   | FC APC  |
|  | <b>07</b>   | E2000   |
|  | <b>08</b>   | E2000 APC   |
| <b>II – Adapters qty (front)</b>         | <b>3-12</b> |   |
| <b>J – Adapter class (front)</b>         | <b>1</b>    | Standard One-Piece (@E2000, FC, ST too)                   |
|  | <b>1T</b>   | Standard One-Piece with transparent cap (only for SC APC) |
|  | <b>2</b>    | Premium One-Piece with internal shutter                   |
|  | <b>3</b>    | Premium Super One-Piece with internal shutter             |
| <b>KK – Adapter type (front)</b>         | <b>01</b>   | SC SX   |
|  | <b>02</b>   | SCA SX  |
|  | <b>03</b>   | E2 SX   |
|  | <b>04</b>   | E2A SX  |
|  | <b>05</b>   | LC 4X   |
|  | <b>06</b>   | LCA 4X  |
|  | <b>07</b>   | FC SX   |
|  | <b>08</b>   | FCA SX  |
|  | <b>09</b>   | ST SX   |
| <b>L – Transmission</b>                  | <b>1</b>    | SM  |
|  | <b>2</b>    | MM (beige @SC/LC, black @E2000)                           |
|  | <b>3</b>    | MM OM3 (aqua @SC/LC)                                      |
|  | <b>4</b>    | MM OM4 (violet @SC/LC)                                    |
| <b>M – MTP®/MPO adapters qty</b>         | <b>1-2</b>  |   |
| <b>N – MTP®/MPO adapters type</b>        | <b>1</b>    | Type A  |
|  | <b>2</b>    | Type B  |

## Example

PS-M1-**A**-**5**-**11G104**-**031051**-**11**

FIBRAIN 3U patch panel module equipped with Direct Split, terminated with female MTP® connector and LC APC connectors on G.652D fiber type, 3 LC APC Standard One-Piece adapters and 1 MTP® Type A adapter

**To order a non-standard option, please contact with our Sales Department.**

# SD modular patch panel, empty



## TECHNICAL SPECIFICATIONS

|                            |                            |
|----------------------------|----------------------------|
| <b>Case material</b>       | Powder paint coated steel  |
| <b>Colour</b>              | Front: chrome-plated steel |
|                            | Closure: Black RAL 9005    |
| <b>Temperature range</b>   | -40°C to +70°C             |
| <b>Max. copper holders</b> | 4                          |
| <b>Max. FO cassettes</b>   | 8                          |
| <b>Scope of supply</b>     | Frame, empty               |
| <b>Weight [kg]</b>         | 2.1                        |

## Ordering information

| Code             | Description                   |
|------------------|-------------------------------|
| <b>XB100.2SD</b> | SD modular patch panel, empty |

## Accessories

See page 140

### Description

- SD patch panel is the most flexible platform for serve either copper or FO connection. It can be equipped up to 24 RJ45 ports of Cat5-Cat6A or up to 96 fibers terminated with wide range of connectors LC/E2000/SC. Patch panel has 8 empty slots which can be equipped with copper holder (6x RJ45) or fully equipped FO cassettes spliced or for pre-terminated connectors including MPO/MTP connectors.

### Applications

- Nodal points of fiber optic networks
- Distribution points of fiber optic networks
- Server rooms

### Features

- Modular configuration system:
  - Possibility for FO/Cu assembling,
  - Different cable entry adapters for different cables fixed in the rear
  - Patch cables manager from front (optional)
- Capacity: up to 8 FO/Cu modules
- Max ports density:
  - 24 port/1U for copper
  - 96 FO fibers (for LCd)
- Full range of connectors:
  - RJ45 – Cat.5u/s, Cat.6u/s, Cat.6Au/s
  - LCd, LCq, E2000, SC, SCd. – MM/SM

# FO cassettes for SD patch panel



### TECHNICAL SPECIFICATIONS

|                            |                            |
|----------------------------|----------------------------|
| <b>Case material</b>       | Powder paint coated steel  |
| <b>Colour</b>              | Front: chrome-plated steel |
|                            | Closure: Black RAL 9005    |
| <b>Temperature range</b>   | -40°C to +70°C             |
| <b>Max. copper holders</b> | 4                          |
| <b>Max. FO cassettes</b>   | 8                          |
| <b>Scope of supply</b>     | Frame, empty               |
| <b>Weight [kg]</b>         | 2.1                        |

### Ordering information

| Code             | Description                   |
|------------------|-------------------------------|
| <b>XB100.2SD</b> | SD modular patch panel, empty |

### Description

→ SD cassettes are compact format FO cassettes which fit to modular SD platform panel of FIBRAIN. SD cassettes are available in wide range of variants. It exists in MM or SM versions, spliced or pre-terminated. Front can be equipped with variety of adapters (LCd, SC, E2000). SD cassettes also can be ordered for MPO/MTP connections.

### Applications

- Nodal points of fiber optic networks
- Distribution points of fiber optic networks
- Server rooms

### Features

- Fully assembled
- Wide range of front (LC/SD/E2000) and rear adapters (
- Singlemode or multimode versions
- Color coding acc. to ISO 11801
- Spliced or pre-terminated solution
- Up to 8 cassettes in 1U
- Secure cable/pigtail guides for internal connections

## Ordering syntax

**XB100.2SD.MF0-A-BCDE-FFGHII-J**

|  |          |  |
|--|----------|--|
| <b>A – Cassette front plate assembling</b> | <b>1</b> | 12x SC SX/LC DX  |
|  | <b>2</b> | 6x SC SX/LC DX   |
|  | <b>3</b> | 6x SC DX/LC 4X   |
|  | <b>4</b> | 3x SC DX/LC 4X   |
| <b>B – Cassette rear side type</b>         | <b>1</b> | Empty (cassette equipped only with front adapters)               |
|  | <b>2</b> | Splice (cassette equipped with pigtails and front adapters)      |
|  | <b>3</b> | 1x MPO/MTP 12F male (factory fully pre-connectorized solution)   |
|  | <b>4</b> | 1x MPO/MTP 12F female (factory fully pre-connectorized solution) |
|  | <b>5</b> | 1x MPO/MTP 24F male (factory fully pre-connectorized solution)   |
|  | <b>6</b> | 1x MPO/MTP 24F female (factory fully pre-connectorized solution) |
|  | <b>7</b> | 2x MPO/MTP 12F male (factory fully pre-connectorized solution)   |
|  | <b>8</b> | 2x MPO/MTP 12F female (factory fully pre-connectorized solution) |
| <b>C – Front adapter class</b>             | <b>1</b> | Standard One-Piece   |
|  | <b>2</b> | Premium Super One-Piece  |
|  | <b>3</b> | Premium One-Piece with internal shutter                          |
|  | <b>4</b> | Premium Super One-Piece with internal shutter                    |
| <b>D – Front adapter type</b>              | <b>1</b> | PC   |
|  | <b>2</b> | APC  |
| <b>E – Transmission</b>                    | <b>1</b> | SM   |
|  | <b>2</b> | MM OM1   |
|  | <b>3</b> | MM OM2   |
|  | <b>4</b> | MM OM3   |
|  | <b>5</b> | MM OM4   |

|   |                  |         |
|---|------------------|---------|
| <b>FF – Pigtails qty</b>                      | <b>6, 12, 24</b> |         |
| <b>G – Fiber type</b>                         | <b>A</b>         | G.652D  |
|   | <b>B</b>         | G.655   |
|   | <b>C</b>         | G.656   |
|   | <b>D</b>         | G.657A1 |
|   | <b>E</b>         | G.657A2 |
|   | <b>F</b>         | G.657B2 |
|   | <b>G</b>         | G.657B3 |
|   | <b>H</b>         | MM OM1  |
|   | <b>I</b>         | MM OM2  |
|   | <b>J</b>         | MM OM3  |
|   | <b>K</b>         | MM OM4  |
| <b>H – Pigtail grade</b>                      | <b>S</b>         | G.652D  |
|   | <b>G</b>         | G.655   |
|   | <b>T</b>         | G.656   |
| <b>II – Colour identification</b>             | <b>01</b>        | G.652D  |
|   | <b>02</b>        | G.655   |
|   | <b>03</b>        | G.656   |
|   | <b>04</b>        | G.657A1 |
|   | <b>05</b>        | G.657A2 |
|   | <b>06</b>        | G.657B2 |
|   | <b>07</b>        | G.657B2 |
| <b>J – Splice heat shrink protection type</b> | <b>1</b>         | 45 mm   |

## Example

**XB100.2SD.MF0-A-BCDE-FFGHII-J**

FIBRAIN rotational patch panel with side access, right, equipped with 4 splice cassettes for 24 splice protectors, 96 Gold grade pigtails terminated with SC PC connectors, 2m length on G.652D fiber, 96 Premium Super One-Piece SC PC adapters and 96 splice protectors 45 mm.

**To order a non-standard option, please contact with our Sales Department.**



# SD patch panel accessories

## Blind cover 0.5U

Blind cover for front of SD patch panel



| DIMENSIONS  |     |
|-------------|-----|
| Length [mm] | 220 |
| Width [mm]  | 129 |
| Height [mm] | 35  |

| ORDERING INFORMATION |                  |
|----------------------|------------------|
| <b>XB100.2SD.PPZ</b> | Blind cover 0,5U |

## Blind cover 1U

Blind cover for rear of SD patch panel



| DIMENSIONS  |     |
|-------------|-----|
| Length [mm] | 220 |
| Width [mm]  | 129 |
| Height [mm] | 35  |

| ORDERING INFORMATION |                |
|----------------------|----------------|
| <b>XB100.2SD.PTZ</b> | Blind cover 1U |

## Cable gland holder for SD patch panel

Cable gland holder for SD Patch panel. Holder can be installed to rear side of panel. It enables to fix 2 cable glands of  $\Phi$  xx



| DIMENSIONS  |     |
|-------------|-----|
| Length [mm] | 220 |
| Width [mm]  | 129 |
| Height [mm] | 35  |

| ORDERING INFORMATION |                    |
|----------------------|--------------------|
| <b>XB100.2SD.PTD</b> | Cable gland holder |

## Cable holder for SD panel

Cable holder enables fixation of cables/tubes which enter SD patch panel. Occupies one rear slot.



| DIMENSIONS  |     |
|-------------|-----|
| Length [mm] | 220 |
| Width [mm]  | 129 |
| Height [mm] | 35  |

| ORDERING INFORMATION |                |
|----------------------|----------------|
| <b>XB100.2SD.PTT</b> | Blind cover 1U |

## Cable holder for SD panel, double

Cable holder intended for fixation of multitube cables. Enables easy installation and distribution tubes within the space of SD patch panel



| DIMENSIONS  |     |
|-------------|-----|
| Length [mm] | 220 |
| Width [mm]  | 129 |
| Height [mm] | 35  |

| ORDERING INFORMATION |                |
|----------------------|----------------|
| <b>XB100.2SD.PTT</b> | Blind cover 1U |

## 19" cable organizer

To arrange cables in SD patch panel. Equipped with a flip cover with a sticker that facilitates markings



| DIMENSIONS  |         |
|-------------|---------|
| Depth [mm]  | 69,5    |
| Width [mm]  | 482     |
| Height [mm] | 44 (1U) |

| ORDERING INFORMATION |                     |
|----------------------|---------------------|
| <b>XB100.2SD.ORG</b> | 19" cable organizer |

# 19" patch panel accessories

## Fiber Optic Patch Panels

### Tubes reserve shelf



| TECHNICAL SPECIFICATION |                      |
|-------------------------|----------------------|
| Height [mm]             | 44 mm (1U)           |
| Width [mm]              | 483 (19")            |
| Depth [mm]              | 258                  |
| Casing material         | Powder painted steel |

#### Description

→ FIBRAIN tubes reserve shelf offers simple and useful way of gathering and storage of fiber optic cable's tube. The shelf is equipped with telescopic rails, which provide a full opening to mount cables easily. Shelf's interior is equipped with a series of ribbing and perforation to provide easier management of fiber optic cable's tube.

#### ORDERING INFORMATION

|                    |                             |
|--------------------|-----------------------------|
| <b>PS-19-1-TUB</b> | FIBRAIN tubes reserve shelf |
|--------------------|-----------------------------|

#### Applications

- FTTH systems
- Last mile distribution points
- Last mile connection points

#### Features & benefits

- Full opening on telescopic rails
- Easy access to fiber optic cable's tube gathered
- Faster installation at construction side
- Shelf's interior facilitating installation and management

### Patchcords reserve shelf



| TECHNICAL SPECIFICATION |                      |
|-------------------------|----------------------|
| Height [mm]             | 44 mm (1U)           |
| Width [mm]              | 483 (19")            |
| Depth [mm]              | 258                  |
| Casing material         | Powder painted steel |

#### Description

→ FIBRAIN tubes reserve shelf offers simple and useful way of gathering and storage of fiber optic cable's tube. The shelf is equipped with telescopic rails, which provide a full opening to mount cables easily. Shelf's interior is equipped with a series of ribbing and perforation to provide easier management of fiber optic cable's tube.

#### ORDERING INFORMATION

|                    |                             |
|--------------------|-----------------------------|
| <b>PS-19-1-PAT</b> | FIBRAIN tubes reserve shelf |
|--------------------|-----------------------------|

#### Applications

- FTTH systems
- Last mile distribution points
- Last mile connection points

#### Features & benefits

- Full opening on telescopic rails
- Easy access to fiber optic cable's tube gathered
- Faster installation at construction side
- Shelf's interior facilitating installation and management

## Horizontal fiber cable organizer



| TECHNICAL SPECIFICATION |                          |
|-------------------------|--------------------------|
| Height [mm]             | 44 mm (1U)               |
| Width [mm]              | 483 (19")                |
| Depth [mm]              | 65                       |
| Casing material         | Anodized aluminium + ABS |

| ORDERING INFORMATION |  |
|----------------------|--|
| PS-ORG-1-PP          | FIBRAIN horizontal fiber optic cable organizer |

### Description

→ FIBRAIN horizontal fiber optic cable organizer is a key elements which facilitate patchcords' management, which are placed between fiber optic equipment in distribution cabinets. This organizer ensures clean and transparent room. Therefore, the organizer is made from anodized aluminium and easily detachable handles made from ABS.

### Applications

- Key points in fiber optic networks
- Distribution points of fiber optic networks
- Server rooms

### Features & benefits

- Height 1U
- Width 19"
- Light and made of anodized aluminium housing
- Easy patchcord's organization
- Detachable handles facilitating cables placement

## Patchcord management for PST-A1 telescopic patch panel

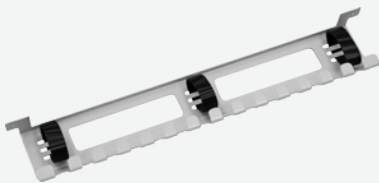

| TECHNICAL SPECIFICATION |                     |
|-------------------------|---------------------|
| Height [mm]             | 35                  |
| Width [mm]              | 423 (19")           |
| Depth [mm]              | 77                  |
| Casing material         | Powder coated steel |

| ORDERING INFORMATION |  |
|----------------------|--|
| FB2030G.V2P          | FIBRAIN patchcord management for PST-A1 telescopic patch panel |

### Description

→ FIBRAIN patchcord management for PST-A1 telescopic patch panel offers simple and useful way of gathering and storage patchcords overlength. FB2030G.V2P is mounted on front plates of PST-A1 patch panel (there is no need to add extra 1U height). Front plate with possibility to mount patchcords using velcro tape.

### Applications

- FTTH systems
- Last mile distribution points
- Last mile connection points

### Features & benefits

- Possibility of mounting on front plates of PST patch panel
- Easy access to patchcords gathered
- Faster installation at construction side
- Front plate facilitating installation and management

# 19" patch panel accessories

## 19" Horizontal cable organizer

with easily-opened plastic handles



| TECHNICAL SPECIFICATION |                      |
|-------------------------|----------------------|
| Height [mm]             | 44 mm (1U)           |
| Width [mm]              | 483 (19")            |
| Depth [mm]              | 69                   |
| Casing material         | Powder painted steel |

| ORDERING INFORMATION  |  |
|-----------------------|--|
| <b>ORG-VP-1U-B-V2</b> | FIBRAIN horizontal cable organizer 19" with red front covers |

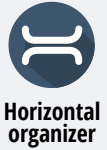
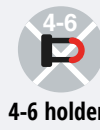

- Features**
- 19" mounting
  - Powder painted steel
  - Equipped with 4 easily opened-handles
  - Possibility of installing 2 extra handles
  - Clear manufacturer marking
  - Possibility of using together with vertical organizers
  - Guarantee optimum cable arrangement

## 19" Vertical cable organizer

with easily-opened plastic handles



| TECHNICAL SPECIFICATION |                      |
|-------------------------|----------------------|
| Height [mm]             | 44 mm (1U)           |
| Width [mm]              | 483 (19")            |
| Depth [mm]              | 69                   |
| Casing material         | Powder painted steel |

| ORDERING INFORMATION  |   |
|-----------------------|---|
| <b>ORG-HP-1U-B-V2</b> | FIBRAIN vertical cable organizer 19" with red front cover |

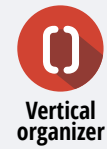
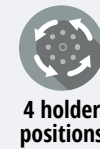

- Features**
- 1U mounting
  - Powder painted steel
  - Equipped with 1 easily opened-handle
  - Possibility of using holder in 4 positions
  - Clear manufacturer marking
  - Guarantee optimum cable arrangement

## Velcro tape

16x200 10 pcs

| FIBRAIN velcro tapes            |                                |
|---------------------------------|--------------------------------|
| <b>ORG-CT-16200-BK</b><br>black | <b>ORG-CT-16200-W</b><br>white |
|                                 |                                |

- Features**
- Material: velour
  - Guarantee optimum cable arrangement
  - Pack of 10 pcs
  - Width: 16 mm - protected against excessive tightening
  - Resistant to multiple opening and closing
  - Colours facilitate cable identification

# Cable tube divider RT-01-xx



## TECHNICAL SPECIFICATIONS

|  | RT-01-0310  | RT-01-1205  | RT-01-2405   |
|--|---|---|--|
| <b>Max. number of protective pipes</b>                                   | 3   | 12  | 24   |
| <b>Max. diameter of protective pipe [mm]</b>                             | 10  | 5   | 5  |
| <b>Max. diameter of fiber optic cable [mm]</b>                           | 14  | 14  | 18   |
| <b>Max. number of cable tube divider installed on Distribution Frame</b> | 8   | 8   | 4  |
| <b>Dimensions of a cable tube divider (w)x(h)x(l) [mm]</b>               | 68 (with mounting) x 46 x 123<br>(no cable gland) | 68 (with mounting) x 46 x 123<br>(no cable gland) | 122 (with mounting) x 53 x 162.5<br>(no cable gland) |
| <b>Operating temperature</b>   | -20°C – +50°C                                     | -20°C – +50°C                                     | -20°C – +50°C  |
| <b>Type of housing material</b>  | Powder painted steel                              | Powder painted steel                              | Powder painted steel                                 |

## Additional accessories

### DISTRIBUTION FRAME

| <b>Distribution Frame for mounting cable tube divider</b> | RT-L8-01-19 |  |
|---|-------------|---|

### PROTECTIVITE PIPES

|                                |                     |
|--------------------------------|---------------------|
| <b>Protectivite pipe 10 mm</b> | OR3F-MYDSN-10-10    |
| <b>Protectivite pipe 5 mm</b>  | OFPT-5.0-3.1-PP-WHT |

## Ordering information

| Code       | Description   |
|------------|---|
| RT-01-0310 | FIBRAIN cable tube divider equipped for mounting 3 protective pipes 10 mm |
| RT-01-1205 | FIBRAIN cable tube divider equipped for mounting 12 protective pipes 5 mm |
| RT-01-2405 | FIBRAIN cable tube divider equipped for mounting 24 protective pipes 5 mm |

### Description

- FIBRAIN cable tube divider is specifically designed to provide branchings of fiber optic cables and guarantee cables' tube protection, which run from RT-01-xx cable tube divider mounted on a Distribution Frame or a Tube Overlength Drawer in signal distribution points, as well in server rooms.
- Therefore, well-thought-out design provides easy and cost-effective method of mounting and cable installation.

### Applications

- Nodal points of fiber optic networks
- Distribution points of fiber optic networks
- Server rooms and cable manufacturing centers

### Features

- Metal housing, protected against corrosion
- Capacity up to 288 fibers
- Prepared for installation
- Simple and clear management of fiber optic tubes

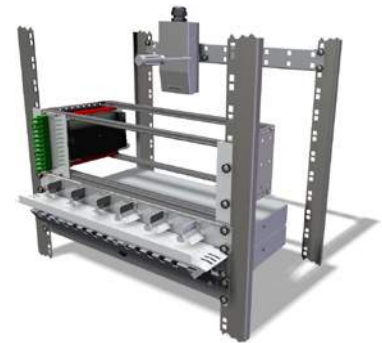

A view of cable tube divider installed on distribution frame

# Heat-shrink splice protection sleeves



## TECHNICAL SPECIFICATIONS

|  | RT-01-1205 | RT-01-2405 |
|--|------------|------------|
| Length of splice protector after shrink L [mm]     | 60         | 45         |
| Length of wire reinforcement L <sub>w</sub> [mm]   | 57         | 41         |
| Diameter of splice protector after shrink D [mm]   | 2          | 2          |
| Diameter of wire reinforcement D <sub>w</sub> [mm] | 0.75       | 0.75       |
| Diameter of the through hole before shrink d [mm]  | 1.2        | 1.2        |

## Ordering information

| Code   | Description                                 |
|--------|---|
| FB7441 | Heat-shrink splice protection sleeves 60 mm |
| FB7442 | Heat-shrink splice protection sleeves 45 mm |

## Also available

| Code   | Description               |
|--------|---------------------------|
| FB7445 | ANT crimp splice prtector |

### Description

→ FIBRAIN FB7442 heat-shrink splice protection sleeves provide high protection during splicing process. They can be characterized by small inner diameter (diameter after shrink D=2.0mm), optimal length and fast installation. Therefore, the heat-shrink sleeve is strengthened with a steel pin of 0.75 mm diameter and the same coefficient of heat expansion as optical fiber. It prevents from longitudinal stresses, which cause an increase of insertion and reflection loss. FIBRAIN heat-shrink sleeves do not cause any loss of optical power as they protect against mechanical damages, pollution and weather conditions. Therefore, the outer material guarantees sustainability and resistance to stretching and puncture.

### Applications

- Telecommunications systems
- FTTH networks
- Access and structured cable networks
- FTTx networks
- PON networks
- CATV networks

### Features

- Small outer diameter
- Strengthened by a pin of Dd = 0.75 mm diameter
- In accordance with UL224, MIL-I-23053, GR-1380-CORE, ZN-96 TPSA-006 norms
- Transparent sleeve
- Max. shrink time: 40 s
- In accordance with RoHS Directive



DTX-PC6AS/MN  
MAIN ISO11EC CAT 6a  
PATCH CORD TEST ADAPTER

DTX-PC6AS/R  
REMOTE ISO11EC CAT 6a  
PATCH CORD TEST ADAPTER

FLUKE networks  
DTX-1800 CableANALYZER



EXIT F1 F2 F3  
ENTER  
SINGLE TEST AUTO TEST  
TEST

**FIBER  
OPTIC**



**TERMINATION**

# TERMINATION OUTLETS

Wide range of FO termination outlets



**EASY TO INSTALL**



**FULL CUSTOMIZATION**



**LARGE & VISIBLE  
LABEL FIELDS**



**SPLICE AND BREAKOUT  
VERSIONS**



# OUTLETS

for breakout and splice applications



WIDE RANGE  
OF SUPPORTED  
ADAPTER TYPES



GUARANTEED  
BENDING RADIUS



SM/MM VERSIONS

# VFTO-E1 Customer Outlet



## TECHNICAL SPECIFICATIONS

|                                     |  |
|-------------------------------------|--|
| <b>Material:</b>                    | ABS UL94-V0  |
| <b>Dimensions (w)x(h)x(d) [mm]:</b> | 85x85x28   |
| <b>Temperature:</b>                 | -20°C – +50°C  |
| <b>Protection level:</b>            | indoor applications IP40/IK05  |
| <b>Mounting:</b>                    | indoor, wall, rail (DIN standard) standard   |
| <b>Cassette capacity:</b>           | 4 fusion, 2 mechanical or 4 ANT splices  |
| <b>Fiber type:</b>                  | 15 mm bending radius, compatible with A1, A2, A3, B2, B3 standards   |
| <b>Length of extra fiber:</b>       | 900 µm – 100 cm fiber in an outlet<br>250 µm – 200 cm fiber in an outlet   |
| <b>Entry ports:</b>                 | 1 entry port in each part of the outlet (1 port on a side) entries from outer part of an outlet (mounting on a flush mount box) all entry ports are defined by removing a blind adapter max. diameter of cables: 4mm |

## Ordering information

| Code                | Description   |
|---------------------|---|
| <b>VFTO-E1-BL-0</b> | FIBRAIN customer outlet in VFTO-E1 option, no logo, not equipped, no mounting adapter on a DIN rail |

| LOGO      |  |
|-----------|--|
| Code      | Description  |
| <b>BL</b> | no logo  |
| <b>FB</b> | FIBRAIN logo   |
| <b>XX</b> | Operator's logo (details concerning printing and number of colours need to be determined individually) |

| SUPPORT FOR VFTO-E1 OUTLET |               |
|----------------------------|---------------|
| Code                       | Description   |
| <b>0</b>                   | none          |
| <b>1</b>                   | VFTO-E1-SUP-1 |
| <b>2</b>                   | VFTO-E1-DIN-1 |

### Description

→ VFTO-E1 customer outlet is specifically designed for FTTH networks as a termination point of an optical duct for max. 4 optical fibers in various home and business networks. The outlet facilitates placing and connecting cables with 2 x SC or 4 x LC pigtails with the use of splices in a cassette. Connectors can be of PC and APC standard with inner and outer shutters. In case of mounting adapters, flangeless adapters should be used.

### Applications

- Distribution network
- FTTH networks with EAC cables
- Last mile connections
- Termination of FTTH networks

### Features

- Compact and innovative design
- Indoor applications
- Wide range of fiber optic adapters
- Description field for adapters on a top part of an outlet with a transparent flip cover
- Available in a customer option (\*lower labour costs)
- Possibility to personalize the outlet (logo)
- Possibility to mount on a DIN rail
- Adapter facilitates the mounting on a wall

# 25x50 angular faceplates

British style system



**XB-50SC45I-01**



**XB-50ST45I-01**

### Description

- 25 x 50 mm angular faceplate for SC and ST fiber optic adapters installation.

### Applications

- Distribution network
- FTTH networks with EAC cables
- Last mile connections
- Termination of FTTH networks

## Technical specifications

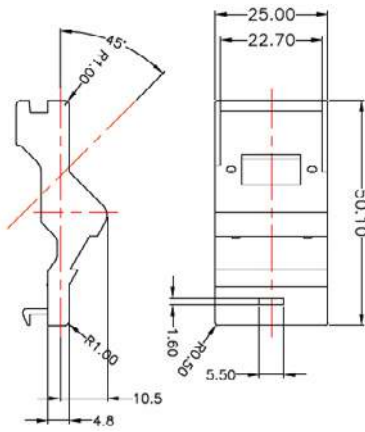

**XB-50SC45I-01**

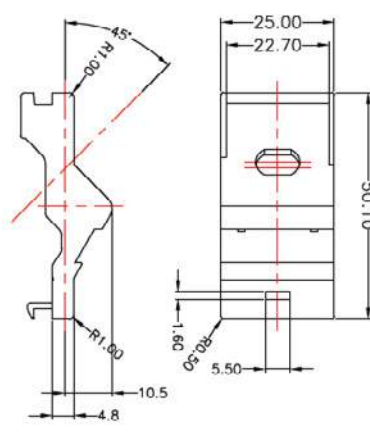

**XB-50ST45I-01**

### Features

- Compatibility with XB-50FPB-0002/4 and XB-50FPF-0002/4 frames
- Labelling field
- Description field and identification icons
- Material: white ABS UL 94V-0

## Ordering information

| Code                 | Description   |
|----------------------|---|
| <b>XB-50SC45I-01</b> | FIBRAIN 25 x 50 mm angular adapter, 1 SC, interchangeable labelling field |
| <b>XB-50ST45I-01</b> | FIBRAIN 25 x 50 mm angular adapter, 1 ST, interchangeable labelling field |

**FIBER  
OPTIC**



**FIBER OPTIC**

# **FIBER OPTIC TEST**

Necessary fiber optic accessories to be used by



**FO CLEANERS FOR WIDE  
RANGE OF CONNECTORS**



**HIGH PERFORMANCE  
ACCESSORIES FOR PROPER  
TESTING OF FO LINKS**

# TEST ACCESSORIES

## ACCESSORIES

every Installer



REFERENCE TEST CORDS  
FOR MM AND SM



REFERENCE PATCH CORDS  
FOR ACCURATE TESTING

# Reference master patchcords

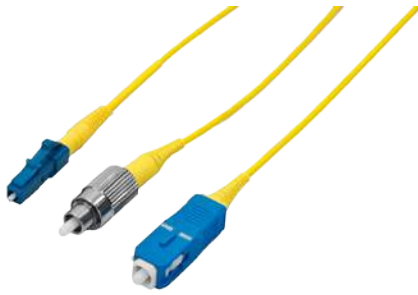

| TECHNICAL SPECIFICATIONS                              |                  |                   |
|---|------------------|-------------------|
| Parameter   | SM PC Connectors | SM APC Connectors |
| Insertion Loss <sup>MAX</sup><br>Acc. IEC 61300-3-34  | ≤ 0.10 dB        | ≤ 0.10 dB         |
| Insertion Loss <sup>97%</sup><br>Acc. IEC 61300-3-34  | ≤ 0.07 dB        | ≤ 0.07 dB         |
| Insertion Loss <sup>MEAN</sup><br>Acc. IEC 61300-3-34 | ≤ 0.05 dB        | ≤ 0.05 dB         |
| Return Loss<br>Acc. IEC 61300-3-6                     | ≥ 55 dB          | ≥ 65 dB           |

| MASTER CONNECTOR END FACE GEOMETRY |   |                       |
|------------------------------------|---|-----------------------|
| Parameter                          | SM PC Connectors                              | SM APC Connectors     |
| Concentricity                      | ≤ 0.30 μm                                     | ≤ 0.30 μm             |
| Bore angle                         | ≤ 0.20 degree                                 | ≤ 0.20 degree         |
| Apex Offset (AO)                   | ≤ 30 μm                                       | ≤ 30 μm               |
| Radius of Curvature (ROC)          | 10 ≤ ROC ≤ 20 mm @ SC<br>7 ≤ ROC ≤ 25 mm @ LC | 7 ≤ ROC ≤ 12 mm       |
| Fiber Height (FH)                  | -30.0 ≤ FH ≤ +30.0 nm                         | -30.0 ≤ FH ≤ +30.0 nm |
| Angle (AN)                         | -   | 7.7 ≤ AN ≤ 8.3 degree |

## Ordering information

| ORDERING SYNTAX |             |      |             |      |            |                      |              |          |       |   |
|-----------------|-------------|------|-------------|------|------------|----------------------|--------------|----------|-------|---|
| Series          | Connector A |      | Connector B |      | Length [m] | Cable                | Fiber        | Diameter | Color |   |
|                 | Class       | Type | Class       | Type |            |                      |              |          |       |   |
| MP              | M Master    | SC   | M Master*   | SC   | 001.0      | SX patchcord simplex | A SMF G.652D | 18 1.8mm | Y     | ■ |
|                 |             | SCA  | G Gold      | SCA  |            |                      | D G657A1     |          |       |   |
|                 |             | LC   |             | LC   |            |                      |              |          |       |   |
|                 |             | LCA  |             | LCA  |            |                      |              |          |       |   |
|                 |             | FC   |             | FC   |            |                      |              |          |       |   |
|                 |             | FCA  |             | FCA  |            |                      |              |          |       |   |
|                 |             |      |             | E2   |            |                      |              |          |       |   |
|                 |             |      |             | E2A  |            |                      |              |          |       |   |
|                 |             |      |             | ST   |            |                      |              |          |       |   |
|                 |             |      |             | MU   |            |                      |              |          |       |   |
|                 |             | DIN  |             |      |            |                      |              |          |       |   |

## Example

**MP-MSCA-MSCA-002.0-SX-A-18-Y** FIBRAIN Master Class Patchcord, with SC APC Master class Connectors at both side, simplex, 2m length, G.652D, cable diameter 1.8mm, yellow coat.

### Description

- Master Class fiber optic patchcords are specifically designed to measure and test telecommunication networks and optical elements. The Master Patchcord is equipped with the highest quality master connector of tightly controlled concentricity and bore angle as well as the end face geometric parameters, which determine very low Insertion Loss and high connection repeatability.
- Optical measurements, in accordance with PN-EN 61280-4-2/-4-1, PN-ISO/IEC 14763-3, ITU-T G.650.3 require the use of the Master Class patchcord. Patchcords can be terminated with two connectors of Master Class or a mixed option: a connector of the Master Class - a standard connector, polished of the Gold Grade. FIBRAIN Master Class of fiber optic connectors can be characterized by very low Insertion Loss and increased control of the ferrule's and face geometry. The control over the end face geometry after polishing process of a fiber optic termination provides the following benefits: guarantees optical performance, minimizes IL, and minimizes back reflection.

### Applications

- Measurements concerning telecommunication networks
- Testing optical devices
- Measuring equipment
- CWDM networks
- Local area network (LAN)
- FTtx, FTTD, FTTB, FTTH networks
- CATV solutions

### Features

- Comply with IEC, TIA/EIA requirements,
- High quality and repeatability of the transmission parameters,
- High quality ceramic ferrules with tightly controlled concentricity and bore angle,
- Very low IL value, IL<sub>TYP</sub> ≤ 0.05 dB,
- Connectors are constructed from high quality plastic, resistant to corrosion and high temperatures with UL94-V0 flammability index.

# OSC – OTDR Starter Cube Launch Fiber



### TECHNICAL SPECIFICATIONS

|   |  |
|---|--|
| Parameter                                   | ABS UL94-V0                                |
| Dimensions (w)x(h)                          | 85x85x28                                   |
| ILMAX @ 1310 nm (SM fiber)                  | -20°C – +50°C                              |
| ILMAX @ 1550 nm (SM fiber)                  | indoor applications IP40/IK05              |
| ILMAX @ 850 nm (MM fiber)                   | indoor, wall, rail (DIN standard) standard |
| ILMAX @ 1300 nm (MM fiber)                  | -20°C – +50°C                              |
| SM Connector Insertion Loss (IEC 61300-3-4) | indoor applications IP40/IK05              |
| MM Connector Insertion Loss (IEC 61300-3-4) | -20°C – +50°C                              |
| Return Loss (IEC 61300-3-6)                 | indoor applications IP40/IK05              |
| Operating temperature                       | 4 fusion, 2 mechanical or 4 ANT splices    |

### Standard fiber lengths

| MM Fibers | SM Fibers |
|-----------|-----------|
| 100 m     | 100 m     |
| 300 m     | 300 m     |
|           | 500 m     |
|           | 1000 m    |

### Ordering information

#### ORDERING SYNTAX

| Series   | Fiber type   | Fanout          | Connector type |         | Length [m] |
|----------|--------------|-----------------|----------------|---------|------------|
|          |              |                 | Input          | Output  |            |
| S-Silver | A G.652D     | 1 - 1.8mm harsh | 1 - E2         | 1 - E2  | 0100       |
|          | B SMF G655   |                 | 2 - E2A        | 2 - E2A |            |
|          | D SMFG657A1  |                 | 3 - FC         | 3 - FC  |            |
|          | E SMF G657A2 |                 | 4 - FCA        | 4 - FCA |            |
|          | H MMF OM1    |                 | 5 - LC         | 5 - LC  |            |
|          | MMF OM2      |                 | 6 - LCA        | 6 - LCA |            |
|          | K MMF OM3    |                 | 7 - SC         | 7 - SC  |            |
|          | L MMF OM4    |                 | 8 - SCA        | 8 - SCA |            |
|          |              |                 | 9 - ST         | 9 - ST  |            |

\*Standard colours of external tube for 1.6-2.8mm cables, other colours can be ordered by a customer on request. Colours in the table concern 0.9mm tube.

### Example

**OSC-A-88-0500** FIBRAIN OSC launch fiber, G.652D fiber, 1.8 mm reinforced harsh tube, SC APC connectors, length 500m

#### Description

FIBRAIN OSC - OTDR Starter Cube - facilitate reflectometric tests with the use of OTDR (Optical Time Domain Reflectometer). The launch fiber eliminates dead zone in reflectometer and guarantees secure measurement. FIBRAIN OSC OTDR Starter Cube has several advantages that make measurements fast and easy to perform. The housing is equipped with a magnet – OSC can be easily mounted on a rack and with shoulder strap – OSC can be easy to transport or moving. Launch fiber is terminated with master class connectors, available in a wide range of connector types. Compact housing can store up to 1000 m of fiber, available in SM or MM type.

#### Applications

- SM and MM network's measurement
- Simulation of loss, length, delayed time and system's reflectance

#### Features

- Compact housing and small weight
- Connector polishing type colour code for clear identification
- Fiber colour code for easy identification
- Input and output fanout made of reinforced harsh tube with crush resistance 1000N
- Magnet mounting allows for mounting OSC to the rack
- Master class connector for accurate and reliable measurement
- Shoulder strap for easy measurement and transport
- Anti-vibes protection

# Cleaner cassette

## FIBRAIN PRO-Cleaner



### Description

→ The main advantage of cleaner cassette FIBRAIN PRO- Cleaners is their universal character of applications- as they can be used for different types of fiber optic connectors, regardless of the diameter of the ferrule. Reel-type cleaners are equipped with a tape with a sliding mechanism, so worn out tape has no contact with connectors that we are going to clean. Therefore, the fillers inside the reel-type cleaners can be easily replaced, which also reduces costs.

### Applications

- Installation works in fiber optic networks
- Maintenance works in fiber optic networks
- Measuring works in fiber optic networks

### Features

- Remove impurities from endface of fiber optic ferrules
- Clean various types of connectors
- Sliding mechanism protects from contact with worn out tape
- Option of replaceable fillers
- High efficiency
- Do not scratch surfaces

### TECHNICAL SPECIFICATIONS

| Reel-type cleaner | Connector                | No. of cleanings | Dimensions   | Photo   |
|-------------------|--------------------------|------------------|--------------|---|
| PC-02-UNV-500     | SC/FC/ST/<br>E2000/LC/MU | 500+             | 130x85x33 mm |   |
| PC-02-UNV-500.R   | SC/FC/ST/<br>E2000/LC/MU | 500+             | Ø47x20 mm    |  |
| PC-02-UNV-700     | SC/FC/ST/<br>E2000/LC/MU | 700+             | 125x56x28 mm |  |
| PC-02-UNV-700.R   | SC/FC/ST/<br>E2000/LC/MU | 700+             | 114x53x25    |  |

### Ordering information

| Code            | Description  |
|-----------------|--|
| PC-02-UNV-500   | FIBRAIN cleaner cassette PRO-Cleaner for fiber optic connectors, universal character of applications, 500+ cleanings |
| PC-02-UNV-500.R | FIBRAIN filler for cleaner cassette PC-02-UNV-500 PRO-Cleaner for fiber optic connectors, 500+ cleanings             |
| PC-02-UNV-700   | FIBRAIN cleaner cassette PRO-Cleaner for fiber optic connectors, universal character of applications, 700+ cleanings |
| PC-02-UNV-700.R | FIBRAIN filler for cleaner cassette PC-02-UNV-700 PRO-Cleaner for fiber optic adapters, 700+ cleanings               |



# One-click FIBRAIN PRO-Cleaner



| TECHNICAL SPECIFICATIONS |                |                  |              |       |
|--------------------------|----------------|------------------|--------------|-------|
| One-click cleaner        | Connector      | No. of cleanings | Dimensions   | Photo |
| PC-01-150-800            | LC/MU          | 800+             | 200x25x25 mm |       |
| PC-01-250-800            | SC/FC/ST/E2000 | 800+             | 200x25x25 mm |       |
| PC-01-150M-800           | LC/MU          | 800+             | 110x30x18 mm |       |
| PC-01-250M-800           | SC/FC/ST/E2000 | 800+             | 110x30x18 mm |       |
| PC-01-MPO-500            | MPO/MTP®       | 500+             | 225x66x15 mm |       |
| PC-01-150M-800           | LC/MU          | 800+             | 110x30x18 mm |       |

## Description

FIBRAIN one-click PRO-Cleaners ensure a very simple, fast and effective way to remove dust and other impurities from the ferrule endface. The series includes cleaning tools adapted to all types of fiber optic connectors - with 2.5 mm ferrules (SC / FC / ST / E2000 with SJ PC or APC), 1.25 mm (LC / MU with SJ PC or APC) and multi-fiber MPO / MTP® connectors. Automatic "one-click" connectors ensure cleaning without the need of unplugging adapters from patch panels. They are available in various options and sizes.

## Applications

- Installation works in fiber optic networks
- Maintenance works in fiber optic networks
- Measuring works in fiber optic networks

## Features

- Remove impurities from endface of fiber optic ferrules
- Available for connectors with ferrule of 2.5 mm, 1.25 mm and MPO/MTP®
- Provide cleaning of connectors that are plugged in patch panels, without the need of unplugging
- The cap for direct cleaning of connectors, which are not plugged in the adapter
- Available mini options that enable cleaning in hard to reach places
- High efficiency
- Do not scratch surfaces

## Ordering information

| Code           | Description  |
|----------------|--|
| PC-01-150-800  | FIBRAIN one-click PRO-Cleaner for fiber optic connectors 1.25 mm (LC/MU), 800+ cleanings       |
| PC-01-150M-800 | FIBRAIN one-click PRO-Cleaner for fiber optic connectors 1.25 mm, mini housing, 800+ cleanings |
| PC-01-250-800  | FIBRAIN one-click PRO-Cleaner for fiber optic connectors 2.5 mm, 800+ cleanings                |
| PC-01-250M-800 | FIBRAIN one-click PRO-Cleaner for fiber optic connectors 2.5 mm, mini housing, 800+ cleanings  |
| PC-01-MPO-500  | FIBRAIN one-click PRO-Cleaner for fiber optic connectors MPO/MTP®, 500+ cleanings              |
| PC-01-MPO-700  | FIBRAIN one-click PRO-Cleaner for fiber optic connectors MPO/MTP®, 700+ cleanings              |

# Adapters cleaning sticks

## FIBRAIN PRO-Cleaner



### Ordering information

| Code         | Description   |
|--------------|---|
| PC-03-125-S5 | 1.25 mm FIBRAIN PRO-Cleaner adapter cleaning sticks, set of 5 pcs |
| PC-03-250-S5 | 2.50 mm FIBRAIN PRO-Cleaner adapter cleaning sticks, set of 5 pcs |

#### Description

→ FIBRAIN dust-free sticks for cleaning fiber optic adapters and in difficult to reach spots. Available in two sizes: for adapters with centering sleeve of 1.25 mm (LC / MU) and of 2.5 mm (SC / FC / ST / E2000). Maintaining clean centering sleeves determines proper optical parameters of the connection.

#### Applications

- Installation works in fiber optic networks
- Maintenance works in fiber optic networks
- Measuring works in fiber optic networks

#### Features

- Removes impurities from fiber optic adapters
- Available in two sizes: 1.25 mm and 2.5 mm
- Proper optical connection parameters due to removing dust from fiber optic adapters
- High efficiency
- Do not scratch surfaces

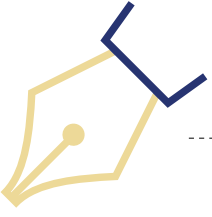

A series of horizontal dashed lines for writing, spanning the width of the page below the pen nib icon.

### **FIBRAIN POLAND**

Rogoźnica 312  
36-060 Głogów Małopolski  
Poland

phone: +48 17 86 60 812  
+48 17 86 60 813  
+48 17 86 60 815

fax +48 17 86 60 811

e-mail: [info@fibrain.com](mailto:info@fibrain.com)

### **FIBRAIN MÉXICO**

Paseo de la Reforma 250 / Piso 9  
Esquina c/Niza, Col. Juárez  
Del. Cuahémoc  
México D.F. 06600

phone: +52 55 3600 7546

e-mail: [info@fibrain.com.mx](mailto:info@fibrain.com.mx)

[www.fibrain.com](http://www.fibrain.com)

**FIBRAIN** ®